



DX EVAPORATOR

2026

50hz

AMMONIA

EVAPORAATORS/AIR COOLERS

- COMMERCIAL CUBIC EVAPORATORS: NEAX	3
- INDUSTRIAL CUBIC EVAPORATORS: NEBX	25
- COMPACT-CEILING AIR TYPE EVAPORATORS: NECX & NECX Plus	49
- DUAL DISCHARGE CEILING AIR TYPE EVAPORATORS: NEDX & NEDX Plus	67
- WALL TYPE EVAPORATORS: NEFX & NEFX Plus	91

EVAPORAATORS/AIR COOLERS

- EVAPORADORES CUBICOS COMERCIALES: NEAX	3
- EVAPORADORES CUBICOS INDUSTRIALES: NEBX	25
- EVAPORADORES COMPACTOS TIPO CÚÑA: NECX & NECX Plus	49
- EVAPORADORES DE TIPO AIRE DE TECHO DE DOBLE DESCARGA: NEDX & NEDX Plus	67
- EVAPORADORES TIPO MURAL: NEFX & NEFX Plus	91



NEAX SERIES EVAPORATOR

EVAPORADORES SERIE NEAX

COMMERCIAL CUBIC EVAPORATORS EVAPORADORES CUBICOS COMERCIALES

The NEAX range of commercial cubic evaporators has been designed for use in cold rooms for the preservation of fresh and frozen products.

The exchange coils used in the NEAX range are highly

The exchange coils used in the NEAX range are highly efficient with special profile aluminum fins and ø12 mm internally grooved SS304 tubes, with a reduced internal volume to reduce the necessary refrigerant charge, meeting the needs of the different international regulations for the reduction of gases with high greenhouse effect. They are supplied clean and tested under a pressure of 30 bar.

01

White powder-coated aluminium casing with high resistance to corrosion and impacts.

02

In models with electric defrost, stainless steel electric heaters covered by aluminum tubes are used, located in the finned package to avoid steam problems and make easy replacement.

03

The electrical parts are connected to an earth terminal, inside a connection box with access holes equipped with cable glands with IP 65 protection.

04

For performance at work points other than those in this catalog, use the "Unit Selector Hybrid HISPANIA" software.



For special applications and additional information consult our Technical Department.

NEAX SERIES EVAPORATORS EVAPORADORES SERIE NEAX

La gama de evaporadores cúbicos comerciales NEAX ha sido diseñada para su uso en cámaras frigoríficas de conservación de productos frescos y congelados.

Los baterías de intercambio utilizadas en la gama NEAX son

Los serpentines de intercambio utilizados en la gama NEAX son de alta eficiencia con aletas de aluminio de perfil especial y tubos ranurados interiormente ø12 mm, con un volumen interno reducido para disminuir la carga de refrigerante necesaria, cumpliendo las necesidades de las diferentes normativas internacionales para la disminución de los gases de alto efecto invernadero. Se suministran limpias y probadas a una presión de 30 bar.

01

La carcasa de aluminio pintado en blanco al polvo electrostático con alta resistencia a la corrosión y a los impactos.

02

En los modelos con desescarche eléctrico se usan resistencias en acero inoxidable cubiertas por tubos de aluminio, situados en el paquete aleteado para evitar problemas de vapor y facilitar la sustitución.

03

Las partes eléctricas están conectadas a un terminal de tierra, dentro de una caja de conexiones con orificios de acceso equipados con prensaestopas con grado de protección IP 65.

04

Para rendimientos en puntos de trabajo distintos a los de este catálogo utilizar el software "Unit Selector Hybrid HISPANIA".



Para aplicaciones especiales e informaciones adicionales consultar a nuestro Departamento Técnico.

NEAX 2503 26 4D S1 2 3

- Fin materials (blank: aluminum, 3: stainless steel, GF: golden fins) / Materiales de las aletas (en blanco: aluminio, 3: acero inoxidable, GF: aletas doradas)
- Casing materials (blank: aluminum, 2: stainless steel) / Materiales de la carcasa (en blanco: aluminio, 2: acero inoxidable)
- Tube materials (1: stainless steel) / Materiales del tubo (1: acero inoxidable)
- Defrost system (blank: air, D: electric, HG: hot gas, W: water, HGD: hot gas & electric, WD: water & electric) / Sistema de descongelación (en blanco: aire, D: eléctrico, HG: gas caliente, W: agua, HGD: gas caliente y eléctrico, WD: agua y electricidad)
- Fin spacing (mm) / Espacio entre aletas (mm)
- Surface (m²) / Superficie (m²)
- Fan number / Número de ventiladores
- Fan \varnothing (mm) / Ventilador \varnothing (mm)
- Series / Serie

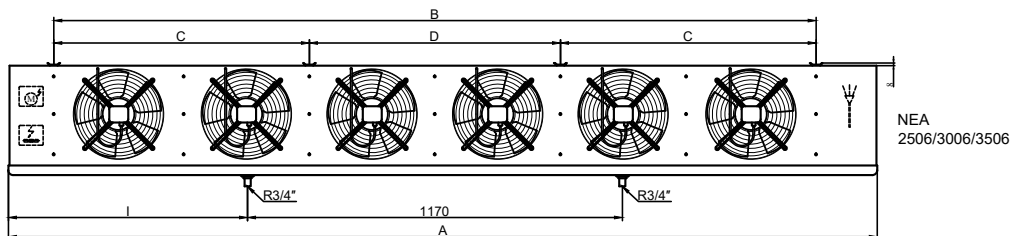
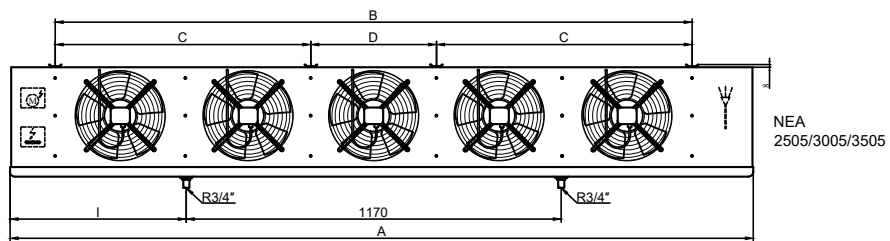
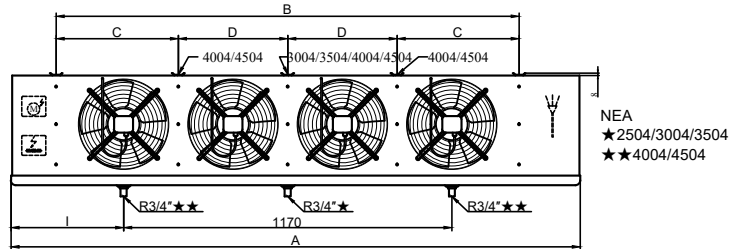
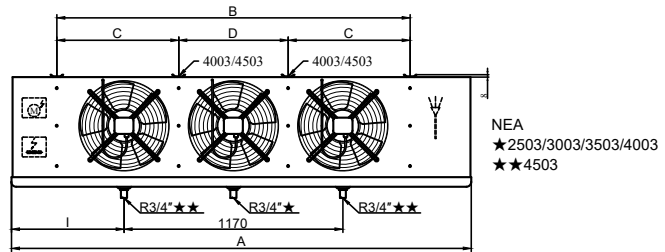
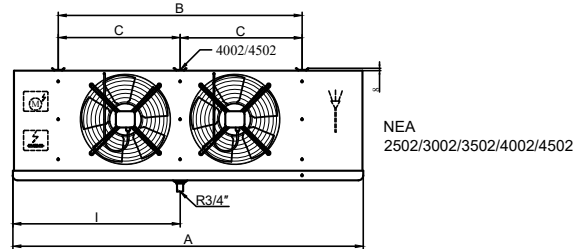
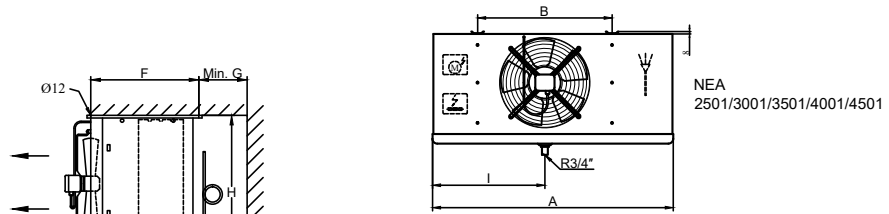

Model / Model	Dimensions / dimensiones(mm)								
	A	B	C	D	E	F	G	H	I
NEAX 2501...	752	420			360	410	200	350	351
NEAX 2502...	1144	812			360	410	200	350	547
NEAX 2503...	1536	1204			360	410	200	350	743
NEAX 2504...	1928	1596	798		360	410	200	350	939
NEAX 2505...	2320	1988	798	392	360	410	200	360	550
NEAX 2506...	2712	2380	798	784	360	410	250	360	746
NEAX 3001...	752	420			360	410	200	460	351
NEAX 3002...	1144	812			360	410	200	460	547
NEAX 3003...	1536	1204			360	410	250	460	743
NEAX 3004...	1928	1596	798		360	410	250	460	939
NEAX 3005...	2320	1988	798	392	360	410	300	470	550
NEAX 3006...	2712	2380	798	784	360	410	300	470	746
NEAX 3501...	752	420			455	507	200	460	351
NEAX 3502...	1144	812			455	507	200	460	547
NEAX 3503...	1536	1204			455	507	250	460	743
NEAX 3504...	1928	1596	798		455	507	250	460	939
NEAX 3505...	2320	1988	798	392	455	507	300	470	550
NEAX 3506...	2712	2380	798	784	455	507	300	470	746
NEAX 4001...	962	630			360	410	250	530	456
NEAX 4002...	1536	1204	602		360	410	300	530	743
NEAX 4003...	1928	1596	546	504	360	410	300	530	939
NEAX 4004...	2712	2380	595	595	360	410	350	540	746
NEAX 4501...	1144	812			360	410	300	600	547
NEAX 4502...	1928	1596	798		360	410	300	600	939
NEAX 4503...	2712	2380	798	784	360	410	350	610	746
NEAX 4504...	3496	3164	798	784	360	410	350	610	1138

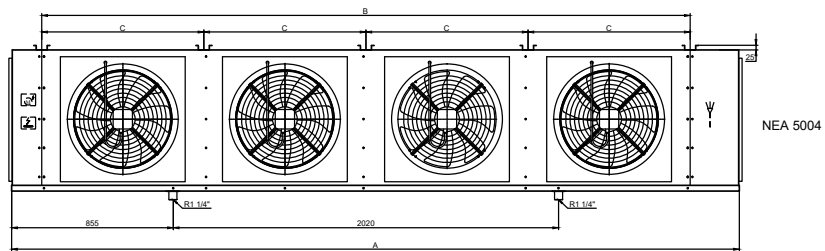
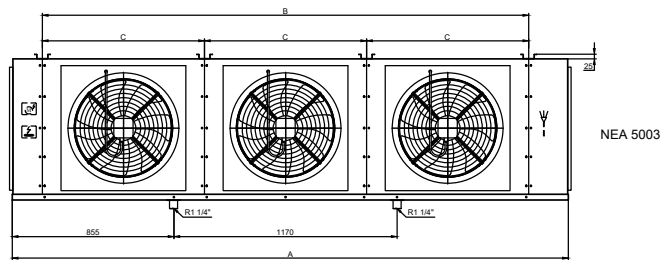
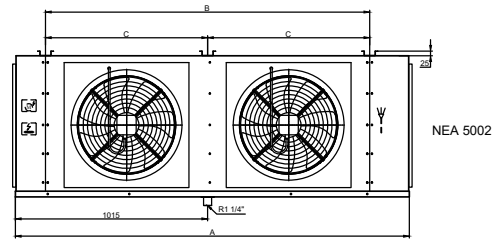
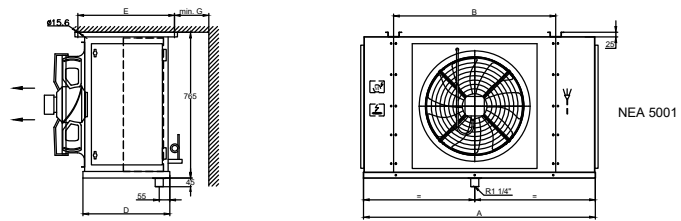

Model / Model	Dimensions / dimensiones(mm)					
	A	B	C	D	E	G
NEAX 5001...(4 rows)	1245	845		455	507	400
NEAX 5001...(6 rows)	1245	845		490	542	400
NEAX 5001...(8 rows)	1245	845		560	612	400
NEAX 5002...(4 rows)	2090	1690	845	455	507	400
NEAX 5002...(6 rows)	2090	1690	845	490	542	400
NEAX 5002...(8 rows)	2090	1690	845	560	612	400
NEAX 5003...(4 rows)	2935	2535	845	455	507	450
NEAX 5003...(6 rows)	2935	2535	845	490	542	450
NEAX 5003...(8 rows)	3005	2535	845	560	612	450
NEAX 5004...(4 rows)	3850	3380	845	455	507	450
NEAX 5004...(6 rows)	3850	3380	845	490	542	450
NEAX 5004...(8 rows)	3850	3380	845	560	612	450

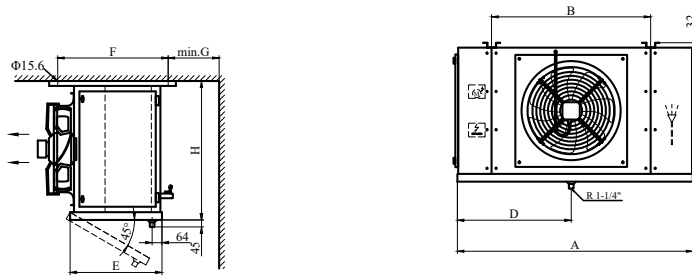

NEA
5501/6301/8001

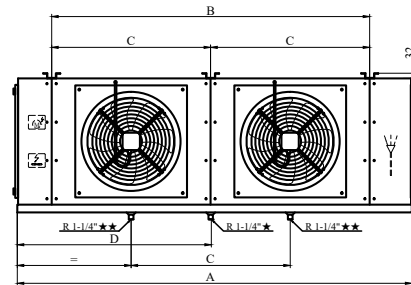

NEA
★5502
★★6302/8002

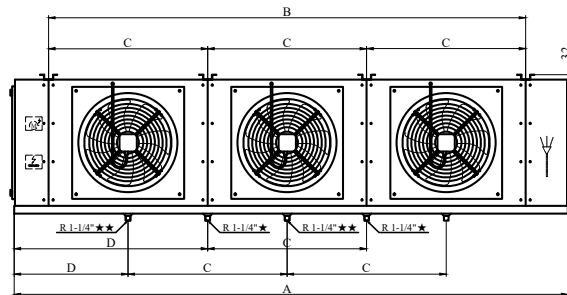

NEA
★5503
★★6303/8003

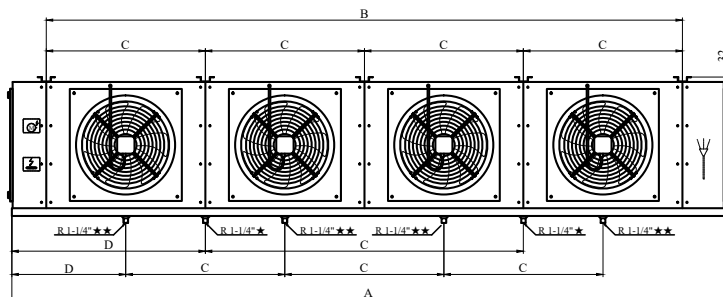

NEA
★5504
★★6304

Model / Model	Dimensions / dimensiones(mm)							
	A	B	C	D	E	F	G	H
NEAX 5501...(4 rows)	1550	1030		750	555	665	260	870
NEAX 5501...(6 rows)	1550	1030		750	555	665	260	870
NEAX 5501...(8 rows)	1550	1030		750	625	735	260	870
NEAX 5502...(4 rows)	2580	2060	1030	1265	555	665	380	870
NEAX 5502...(6 rows)	2580	2060	1030	1265	555	665	380	870
NEAX 5502...(8 rows)	2580	2060	1030	1265	625	735	380	870
NEAX 5503...(4 rows)	3610	3090	1030	750	555	665	460	870
NEAX 5503...(6 rows)	3610	3090	1030	750	555	665	460	870
NEAX 5503...(8 rows)	3610	3090	1030	750	625	735	460	870
NEAX 5504...(4 rows)	4640	4120	1030	750	555	665	500	870
NEAX 5504...(6 rows)	4640	4120	1030	750	555	665	500	870
NEAX 5504...(8 rows)	4640	4120	1030	750	625	735	500	870
NEAX 6301...(4 rows)	1750	1230		850	600	710	310	1010
NEAX 6301...(6 rows)	1750	1230		850	600	710	310	1010
NEAX 6301...(8 rows)	1750	1230		850	670	780	310	1010
NEAX 6301...(10 rows)	1750	1230		850	740	850	310	1010
NEAX 6302...(4 rows)	2980	2460	1230	850	600	710	440	1010
NEAX 6302...(6 rows)	2980	2460	1230	850	600	710	440	1010
NEAX 6302...(8 rows)	2980	2460	1230	850	670	780	440	1010
NEAX 6302...(10 rows)	2980	2460	1230	850	740	850	440	1010
NEAX 6303...(4 rows)	4210	3690	1230	850	600	710	530	1010
NEAX 6303...(6 rows)	4210	3690	1230	850	600	710	530	1010
NEAX 6303...(8 rows)	4210	3690	1230	850	670	780	530	1010
NEAX 6303...(10 rows)	4210	3690	1230	850	740	850	530	1010
NEAX 6304...(4 rows)	5440	4920	1230	850	600	710	580	1010
NEAX 6304...(6 rows)	5440	4920	1230	850	600	710	580	1010
NEAX 6304...(8 rows)	5440	4920	1230	850	670	780	580	1010
NEAX 6304...(10 rows)	5440	4920	1230	850	740	850	580	1010
NEAX 8001...(4 rows)	1950	1430		950	665	775	390	1360
NEAX 8001...(6 rows)	1950	1430		950	665	775	390	1360
NEAX 8001...(8 rows)	1950	1430		950	735	845	390	1360
NEAX 8001...(10 rows)	1950	1430		950	805	915	390	1360
NEAX 8002...(4 rows)	3380	2860	1430	950	665	775	580	1360
NEAX 8002...(6 rows)	3380	2860	1430	950	665	775	580	1360
NEAX 8002...(8 rows)	3380	2860	1430	950	735	845	580	1360
NEAX 8002...(10 rows)	3380	2860	1430	950	805	915	580	1360
NEAX 8003...(4 rows)	4810	4290	1430	950	665	775	700	1360
NEAX 8003...(6 rows)	4810	4290	1430	950	665	775	700	1360
NEAX 8003...(8 rows)	4810	4290	1430	950	735	845	700	1360
NEAX 8003...(10 rows)	4810	4290	1430	950	805	915	700	1360

The number of rows refers to the number of tube rows in width in the heat exchanger. The number of rows can be found in the characteristics of each evaporator on the following pages.

El número de filas se refiere al número de filas de tubos en anchura en el intercambiador de calor. Se puede ver el número de filas en las características de cada evaporador en las páginas siguientes.

FIN SPACING 4 mm, with electrical defrost. Rt>=0°C
SEPARACIÓN ALETAS 4 mm, con desescarche eléctrico. Rt>=0°C

Modelo / Model	Capacidad / Capacity R717 (kw)		Superficie / Surface (m ²)	Volumen interno / Tube Volume (dm ³)	Filas de serpentin / Coil Rows	Peso Neto / N.W. (kg)	Conexión / Connection (ømm)	
	te= -8°C	te= -25°C					Entrada / Inlet	Salida / Outlet
	DT1=8K	DT1=7K						
NEAX 2501 09 4D	1.57	1.17	8.3	1.4		19.5	DN6	DN6
NEAX 2502 17 4D	3.15	2.37	16.7	2.8		31.4	DN10	DN15
NEAX 2503 26 4D	4.97	3.63	25.1	4.2		43.2	DN10	DN15
NEAX 2504 35 4D	6.59	4.87	33.5	5.6		55.3	DN15	DN20
NEAX 2505 41 4D	8.34	6.03	41.8	7		67.7	DN15	DN20
NEAX 2506 52 4D	9.97	7.01	50.2	8.5		79.6	DN15	DN20
NEAX 3001 12 4D	2.57	1.82	11.1	1.9		23.9	DN6	DN6
NEAX 3002 23 4D	5.21	3.73	22.3	3.8		39	DN10	DN15
NEAX 3003 35 4D	7.55	5.6	33.5	5.6		54.1	DN15	DN20
NEAX 3004 46 4D	10.48	7.56	44.6	7.5		69.4	DN15	DN20
NEAX 3005 56 4D	13.21	9.27	55.8	9.4		84.9	DN20	DN25
NEAX 3006 69 4D	15.76	11.39	67	11.3		99.9	DN20	DN25
NEAX 3501 14 4D	3.43	2.64	13.9	2.3		30.8	DN10	DN15
NEAX 3502 27 4D	7.28	5.39	27.9	4.7		51.1	DN15	DN20
NEAX 3503 41 4D	10.37	8.02	41.8	7		71.7	DN15	DN20
NEAX 3504 55 4D	14.64	10.88	55.8	9.4		92.5	DN20	DN25
NEAX 3505 70 4D	18.70	13.53	69.7	11.7		113.6	DN25	DN32
NEAX 3506 83 4D	21.62	16.33	83.7	14.1		134.1	DN25	DN32
NEAX 4001 20 4D	5.58	4.01	19.9	3.4		35.8	DN10	DN15
NEAX 4002 40 4D	11.05	8.03	39	6.6		61.3	DN15	DN20
NEAX 4003 54 4D	15.51	10.76	52.1	8.8		81.1	DN20	DN25
NEAX 4004 81 4D	22.46	16.05	78.1	13.2		113.1	DN25	DN32
NEAX 4501 31 4D	8.74	6.59	29.7	5		49.9	DN15	DN20
NEAX 4502 61 4D	17.55	13.26	59.5	10		88.6	DN20	DN25
NEAX 4503 92 4D	27.93	19.77	89.3	15		127.2	DN25	DN32
NEAX 4504 119 4D	35.16	26.61	119.1	20		166.5	DN25	DN32
NEAX 5001 39 4D	12.07	8.75	37.8	6.4	4	83.2	DN15	DN20
NEAX 5001 58 4D	14.98	10.94	56.6	9.5	6	100.5	DN20	DN25
NEAX 5001 76 4D	16.52	12.21	75.5	12.7	8	118.1	DN20	DN25
NEAX 5002 81 4D	24.90	18.03	78.1	13.2	4	145.9	DN25	DN32
NEAX 5002 121 4D	31.32	22.39	117.2	19.7	6	174.3	DN25	DN32
NEAX 5002 156 4D	34.08	25.23	156.2	26.3	8	203.2	DN32	DN40
NEAX 5003 122 4D	38.37	26.82	119.7	20.1	4	208.7	DN32	DN40
NEAX 5003 183 4D	47.79	34.18	179.5	30.2	6	251	DN40	DN50
NEAX 5003 237 4D	52.42	38.26	237	39.9	8	293	DN40	DN50
NEAX 5004 159 4D	48.83	36.65	158.9	26.7	4	272.7	DN40	DN50
NEAX 5004 238 4D	63.61	45.58	238.3	40.1	6	328.4	DN40	DN50
NEAX 5004 318 4D	66.82	50.2	317.7	53.5	8	386.9	DN40	DN50

Modelo / Model	Ventilador con Motor Axial / Axial Fans							Desescarche Eléctrico Electric Defrost		
	Diámetro / Diameter (ø mm)	Nº	Voltaje / Voltage (V, 50Hz)	Potencia / Power (W)	Intensidad / Current (A)	Flujo de aire / Air Flow (m3/h)	Tiro / Air Throw (m)	Aletas / Coil (W)	Desagüe / Drain Pan (W)	Total / Total (W)
NEAX 2501 09 4D	250	1	1 ~ 230	50	0.2	739	4	2 × 440	1 × 440	1320
NEAX 2502 17 4D	250	2	1 ~ 230	100	0.5	1481	5	2 × 730	1 × 730	2190
NEAX 2503 26 4D	250	3	1 ~ 230	150	0.7	2219	6	2 × 1030	1 × 1030	3090
NEAX 2504 35 4D	250	4	1 ~ 230	200	0.9	2960	7	2 × 1310	1 × 1310	3930
NEAX 2505 41 4D	250	5	1 ~ 230	250	1.2	3699	8	2 × 1600	1 × 1600	4800
NEAX 2506 52 4D	250	6	1 ~ 230	300	1.4	4438	10	2 × 1890	1 × 1890	5670
NEAX 3001 12 4D	300	1	1 ~ 230	72	0.3	1286	6	3 × 440	1 × 440	1760
NEAX 3002 23 4D	300	2	1 ~ 230	144	0.6	2575	7	3 × 730	1 × 730	2920
NEAX 3003 35 4D	300	3	1 ~ 230	216	1.0	3866	9	3 × 1030	1 × 1030	4120
NEAX 3004 46 4D	300	4	1 ~ 230	288	1.3	5152	10	3 × 1310	1 × 1310	5240
NEAX 3005 56 4D	300	5	1 ~ 230	360	1.6	6438	13	3 × 1600	1 × 1600	6400
NEAX 3006 69 4D	300	6	1 ~ 230	432	1.9	7729	15	3 × 1890	1 × 1890	7560
NEAX 3501 14 4D	350	1	1 ~ 230	130	0.6	1759	10	4 × 440	2 × 440	2640
NEAX 3502 27 4D	350	2	1 ~ 230	260	1.2	3518	13	4 × 730	2 × 730	4380
NEAX 3503 41 4D	350	3	1 ~ 230	390	1.7	5287	16	4 × 1030	2 × 1030	6180
NEAX 3504 55 4D	350	4	1 ~ 230	520	2.3	7041	19	4 × 1310	2 × 1310	7860
NEAX 3505 70 4D	350	5	1 ~ 230	650	2.9	8795	21	4 × 1600	2 × 1600	9600
NEAX 3506 83 4D	350	6	1 ~ 230	780	3.5	10569	23	4 × 1890	2 × 1890	11340
NEAX 4001 20 4D	400	1	1 ~ 230	160	0.7	3135	11	4 × 550	1 × 550	2750
NEAX 4002 40 4D	400	2	1 ~ 230	320	1.5	6210	13	4 × 1030	1 × 1030	5150
NEAX 4003 54 4D	400	3	1 ~ 230	480	2.2	8810	16	4 × 1310	1 × 1310	6550
NEAX 4004 81 4D	400	4	1 ~ 230	640	2.9	12418	19	4 × 1890	1 × 1890	9450
NEAX 4501 31 4D	450	1	3 ~ 400	460	1.0	5459	15	4 × 730	1 × 730	3650
NEAX 4502 61 4D	450	2	3 ~ 400	920	1.9	10923	18	4 × 1310	1 × 1310	6550
NEAX 4503 92 4D	450	3	3 ~ 400	1380	2.9	16367	21	4 × 1890	1 × 1890	9450
NEAX 4504 119 4D	450	4	3 ~ 400	1840	3.8	21850	23	4 × 2470	1 × 2470	12350
NEAX 5001 39 4D	500	1	3 ~ 400	820	1.6	7451	20	6 × 730	1 × 730	5110
NEAX 5001 58 4D	500	1	3 ~ 400	820	1.6	6669	17	7 × 730	2 × 730	6570
NEAX 5001 76 4D	500	1	3 ~ 400	820	1.6	6088	14	8 × 730	2 × 730	7300
NEAX 5002 81 4D	500	2	3 ~ 400	1640	3.2	15095	24	6 × 1400	1 × 1400	9800
NEAX 5002 121 4D	500	2	3 ~ 400	1640	3.2	13554	20	7 × 1400	2 × 1400	12600
NEAX 5002 156 4D	500	2	3 ~ 400	1640	3.2	12409	16	8 × 1400	2 × 1400	14000
NEAX 5003 122 4D	500	3	3 ~ 400	2460	4.8	22805	29	6 × 2050	1 × 2050	14350
NEAX 5003 183 4D	500	3	3 ~ 400	2460	4.8	20535	24	7 × 2050	2 × 2050	18450
NEAX 5003 237 4D	500	3	3 ~ 400	2460	4.8	18722	19	8 × 2050	2 × 2050	20500
NEAX 5004 159 4D	500	4	3 ~ 400	3280	6.4	30392	34	6 × 3390	1 × 3390	23730
NEAX 5004 238 4D	500	4	3 ~ 400	3280	6.4	27322	29	7 × 3390	2 × 3390	30510
NEAX 5004 318 4D	500	4	3 ~ 400	3280	6.4	25056	24	8 × 3390	2 × 3390	33900

FIN SPACING 6 mm, with electrical defrost. Rt>=-18°C
SEPARACIÓN ALETAS 6 mm, con desescarche eléctrico. Rt>=-18°C

Modelo / Model	Capacidad / Capacity R717 (kw)		Superficie / Surface (m ²)	Volumen interno / Tube Volume (dm ³)	Filas de serpentin / Coil Rows	Peso Neto / N.W. (kg)	Conexión / Connection (ømm)	
	te= -8°C	te= -25°C					Entrada / Inlet	Salida / Outlet
	DT1=8K	DT1=7K						
NEAX 2501 06 6D	1.34	1	5.7	1.4		18.7	DN6	DN6
NEAX 2502 11 6D	2.70	2.0	11.5	2.8		30.8	DN10	DN15
NEAX 2503 17 6D	4.30	3.1	17.3	4.2		42.2	DN10	DN15
NEAX 2504 23 6D	5.68	4.2	23	5.6		54	DN15	DN20
NEAX 2505 29 6D	7.24	5.2	28.8	7		66.1	DN15	DN20
NEAX 2506 35 6D	8.72	6.1	34.5	8.5		77.6	DN15	DN20
NEAX 3001 08 6D	2.17	1.6	7.6	1.9		23.4	DN6	DN6
NEAX 3002 15 6D	4.37	3.2	15.3	3.8		38.1	DN10	DN15
NEAX 3003 23 6D	6.29	4.7	23	5.6		52.6	DN15	DN20
NEAX 3004 31 6D	8.79	6.4	30.7	7.5		67.7	DN15	DN20
NEAX 3005 38 6D	11.17	8.0	38.4	9.4		82.7	DN20	DN25
NEAX 3006 46 6D	13.20	9.6	46.1	11.3		97.3	DN20	DN25
NEAX 3501 10 6D	2.96	2.3	9.6	2.3		30.3	DN10	DN15
NEAX 3502 19 6D	6.32	4.7	19.2	4.7		50	DN15	DN20
NEAX 3503 28 6D	8.94	6.9	28.8	7		70	DN15	DN20
NEAX 3504 38 6D	12.70	9.5	38.4	9.4		90.4	DN20	DN25
NEAX 3505 48 6D	16.33	11.9	48	11.7		110.9	DN25	DN32
NEAX 3506 57 6D	18.71	14.2	57.6	14.1		130.9	DN25	DN32
NEAX 4001 13 6D	4.65	3.4	13.7	3.4		35.1	DN10	DN15
NEAX 4002 27 6D	9.20	6.7	26.8	6.6		59.8	DN15	DN20
NEAX 4003 36 6D	13.12	9.3	35.8	8.8		79.1	DN20	DN25
NEAX 4004 54 6D	18.77	13.5	53.7	13.2		110.1	DN25	DN32
NEAX 4501 20 6D	7.18	5.4	20.4	5		48.7	DN15	DN20
NEAX 4502 41 6D	14.40	10.9	40.9	10		86.3	DN20	DN25
NEAX 4503 61 6D	23.19	16.6	61.4	15		123.7	DN25	DN32
NEAX 4504 82 6D	28.85	21.9	81.9	20		161.9	DN25	DN32
NEAX 5001 26 6D	10.00	7.3	26	6.4	4	81.6	DN15	DN20
NEAX 5001 39 6D	13.00	9.5	39	9.5	6	98.2	DN20	DN25
NEAX 5001 52 6D	14.93	11.01	51.9	12.7	8	115	DN20	DN25
NEAX 5002 54 6D	20.62	15.0	53.7	13.2	4	142.8	DN25	DN32
NEAX 5002 81 6D	27.33	19.7	80.6	19.7	6	169.7	DN25	DN32
NEAX 5002 108 6D	30.77	22.74	107.5	26.3	8	197.1	DN32	DN40
NEAX 5003 82 6D	31.99	22.7	82.3	20.1	4	204.1	DN32	DN40
NEAX 5003 122 6D	41.69	30.1	123.5	30.2	6	244.1	DN40	DN50
NEAX 5003 163 6D	47.57	34.76	163	39.9	8	283.9	DN40	DN50
NEAX 5004 109 6D	40.16	30.19	109.3	26.7	4	266.6	DN40	DN50
NEAX 5004 164 6D	55.47	40.04	163.9	40.1	6	319.1	DN40	DN50
NEAX 5004 219 6D	59.99	45.19	218.5	53.5	8	374.6	DN40	DN50

Modelo / Model	Ventilador con Motor Axial / Axial Fans							Desescarche Eléctrico Electric Defrost		
	Diámetro / Diameter (ø mm)	Nº	Voltaje / Voltage (V, 50Hz)	Potencia / Power (W)	Intensidad / Current (A)	Flujo de aire / Air Flow (m3/h)	Tiro / Air Throw (m)	Aletas / Coil (W)	Desagüe / Drain Pan (W)	Total / Total (W)
NEAX 2501 06 6D	250	1	1 ~ 230	50	0.2	801	4	2 × 440	1 × 440	1320
NEAX 2502 11 6D	250	2	1 ~ 230	100	0.5	1605	5	2 × 730	1 × 730	2190
NEAX 2503 17 6D	250	3	1 ~ 230	150	0.7	2405	6	2 × 1030	1 × 1030	3090
NEAX 2504 23 6D	250	4	1 ~ 230	200	0.9	3208	7	2 × 1310	1 × 1310	3930
NEAX 2505 29 6D	250	5	1 ~ 230	250	1.2	4008	8	2 × 1600	1 × 1600	4800
NEAX 2506 35 6D	250	6	1 ~ 230	300	1.4	4808	10	2 × 1890	1 × 1890	5670
NEAX 3001 08 6D	300	1	1 ~ 230	72	0.3	1349	6	3 × 440	1 × 440	1760
NEAX 3002 15 6D	300	2	1 ~ 230	144	0.6	2700	7	3 × 730	1 × 730	2920
NEAX 3003 23 6D	300	3	1 ~ 230	216	1.0	4054	9	3 × 1030	1 × 1030	4120
NEAX 3004 31 6D	300	4	1 ~ 230	288	1.3	5401	11	3 × 1310	1 × 1310	5240
NEAX 3005 38 6D	300	5	1 ~ 230	360	1.6	6749	13	3 × 1600	1 × 1600	6400
NEAX 3006 46 6D	300	6	1 ~ 230	432	1.9	8103	15	3 × 1890	1 × 1890	7560
NEAX 3501 10 6D	350	1	1 ~ 230	130	0.6	1920	10	4 × 440	2 × 440	2640
NEAX 3502 19 6D	350	2	1 ~ 230	260	1.2	3838	14	4 × 730	2 × 730	4380
NEAX 3503 28 6D	350	3	1 ~ 230	390	1.7	5770	16	4 × 1030	2 × 1030	6180
NEAX 3504 38 6D	350	4	1 ~ 230	520	2.3	7681	20	4 × 1310	2 × 1310	7860
NEAX 3505 48 6D	350	5	1 ~ 230	650	2.9	9594	22	4 × 1600	2 × 1600	9600
NEAX 3506 57 6D	350	6	1 ~ 230	780	3.5	11531	24	4 × 1890	2 × 1890	11340
NEAX 4001 13 6D	400	1	1 ~ 230	160	0.7	3290	11	4 × 550	1 × 550	2750
NEAX 4002 27 6D	400	2	1 ~ 230	320	1.5	6529	14	4 × 1030	1 × 1030	5150
NEAX 4003 36 6D	400	3	1 ~ 230	480	2.2	9356	16	4 × 1310	1 × 1310	6550
NEAX 4004 54 6D	400	4	1 ~ 230	640	2.9	13056	19	4 × 1890	1 × 1890	9450
NEAX 4501 20 6D	450	1	3 ~ 400	460	1.0	5688	15	4 × 730	1 × 730	3650
NEAX 4502 41 6D	450	2	3 ~ 400	920	1.9	11380	18	4 × 1310	1 × 1310	6550
NEAX 4503 61 6D	450	3	3 ~ 400	1380	2.9	17051	22	4 × 1890	1 × 1890	9450
NEAX 4504 82 6D	450	4	3 ~ 400	1840	3.8	22764	24	4 × 2470	1 × 2470	12350
NEAX 5001 26 6D	500	1	3 ~ 400	820	1.6	7805	24	6 × 730	1 × 730	5110
NEAX 5001 39 6D	500	1	3 ~ 400	820	1.6	7086	21	7 × 730	2 × 730	6570
NEAX 5001 52 6D	500	1	3 ~ 400	820	1.6	6521	18	8 × 730	2 × 730	7300
NEAX 5002 54 6D	500	2	3 ~ 400	1640	3.2	15784	24	6 × 1400	1 × 1400	9800
NEAX 5002 81 6D	500	2	3 ~ 400	1640	3.2	14377	20	7 × 1400	2 × 1400	12600
NEAX 5002 108 6D	500	2	3 ~ 400	1640	3.2	13264	16	8 × 1400	2 × 1400	14000
NEAX 5003 82 6D	500	3	3 ~ 400	2460	4.8	23823	29	6 × 2050	1 × 2050	14350
NEAX 5003 122 6D	500	3	3 ~ 400	2460	4.8	21762	24	7 × 2050	2 × 2050	18450
NEAX 5003 163 6D	500	3	3 ~ 400	2460	4.8	19997	19	8 × 2050	2 × 2050	20500
NEAX 5004 109 6D	500	4	3 ~ 400	3280	6.4	31757	34	6 × 3390	1 × 3390	23730
NEAX 5004 164 6D	500	4	3 ~ 400	3280	6.4	28960	29	7 × 3390	2 × 3390	30510
NEAX 5004 219 6D	500	4	3 ~ 400	3280	6.4	26760	24	8 × 3390	2 × 3390	33900

FIN SPACING 9 mm, with electrical defrost. Rt>=-35°C
SEPARACIÓN ALETAS 9 mm, con desescarche eléctrico. Rt>=-35°C

Modelo / Model	Capacidad / Capacity R717 (kw)		Superficie / Surface (m ²)	Volumen interno / Tube Volume (dm ³)	Filas de serpentin / Coil Rows	Peso Neto / N.W. (kg)	Conexión / Connection (ømm)	
	te= -8°C	te= -25°C					Entrada / Inlet	Salida / Outlet
	DT1=8K	DT1=7K						
NEAX 2501 04 9D	1.09	0.81	4	1.4		18.7	DN6	DN6
NEAX 2502 08 9D	2.18	1.62	8	2.8		29.9	DN10	DN15
NEAX 2503 12 9D	3.50	2.55	12	4.2		41	DN10	DN15
NEAX 2504 16 9D	4.61	3.38	16.1	5.6		52.4	DN15	DN20
NEAX 2505 20 9D	5.91	4.28	20.1	7		64.1	DN15	DN20
NEAX 2506 24 9D	7.15	5.11	24.1	8.5		75.2	DN15	DN20
NEAX 3001 06 9D	1.76	1.27	5.3	1.9		22.8	DN6	DN6
NEAX 3002 10 9D	3.54	2.57	10.7	3.8		37	DN10	DN15
NEAX 3003 16 9D	5.06	3.76	16	5.6		51	DN15	DN20
NEAX 3004 21 9D	7.11	5.19	21.4	7.5		65.5	DN15	DN20
NEAX 3005 27 9D	9.09	6.55	26.8	9.4		80	DN20	DN25
NEAX 3006 31 9D	10.68	7.8	32.1	11.3		94.1	DN20	DN25
NEAX 3501 07 9D	2.46	1.89	6.7	2.3		29.5	DN10	DN15
NEAX 3502 13 9D	5.28	3.92	13.4	4.7		48.6	DN15	DN20
NEAX 3503 20 9D	7.42	5.71	20.1	7		68	DN15	DN20
NEAX 3504 27 9D	10.60	7.87	26.8	9.4		87.7	DN20	DN25
NEAX 3505 34 9D	13.69	10	33.5	11.7		107.5	DN25	DN32
NEAX 3506 40 9D	15.58	11.73	40.2	14.1		126.9	DN25	DN32
NEAX 4001 09 9D	3.74	2.72	9.6	3.4		34.1	DN10	DN15
NEAX 4002 18 9D	7.39	5.41	18.7	6.6		57.9	DN15	DN20
NEAX 4003 24 9D	10.66	7.63	25	8.8		76.6	DN20	DN25
NEAX 4004 36 9D	15.11	10.98	37.5	13.2		106.3	DN25	DN32
NEAX 4501 14 9D	5.71	4.31	14.3	5		47.2	DN15	DN20
NEAX 4502 28 9D	11.45	8.66	28.5	10		83.4	DN20	DN25
NEAX 4503 41 9D	18.59	13.45	42.8	15		119.5	DN25	DN32
NEAX 4504 57 9D	22.92	17.35	57.1	20		156.2	DN25	DN32
NEAX 5001 17 9D	8.01	5.87	18.1	6.4	4	79.7	DN15	DN20
NEAX 5001 26 9D	10.82	7.96	27.2	9.5	6	95.4	DN20	DN25
NEAX 5001 36 9D	12.88	9.51	36.2	12.7	8	111.2	DN20	DN25
NEAX 5002 36 9D	16.48	12.04	37.5	13.2	4	139	DN25	DN32
NEAX 5002 54 9D	22.84	16.56	56.2	19.7	6	163.9	DN25	DN32
NEAX 5002 75 9D	26.53	19.59	75	26.3	8	189.4	DN32	DN40
NEAX 5003 54 9D	25.70	18.47	57.4	20.1	4	198.4	DN32	DN40
NEAX 5003 82 9D	34.82	25.26	86.1	30.2	6	235.5	DN40	DN50
NEAX 5003 114 9D	41.19	30.19	113.7	39.9	8	272.4	DN40	DN50
NEAX 5004 76 9D	31.92	23.96	76.2	26.7	4	258.9	DN40	DN50
NEAX 5004 114 9D	46.32	33.64	114.3	40.1	6	307.6	DN40	DN50
NEAX 5004 152 9D	51.5	38.83	152.4	53.5	8	359.3	DN40	DN50

Modelo / Model	Ventilador con Motor Axial / Axial Fans							Desescarche Eléctrico Electric Defrost		
	Diámetro / Diameter (ø mm)	Nº	Voltaje / Voltage (V, 50Hz)	Potencia / Power (W)	Intensidad / Current (A)	Flujo de aire / Air Flow (m3/h)	Tiro / Air Throw (m)	Aletas / Coil (W)	Desagüe / Drain Pan (W)	Total / Total (W)
NEAX 2501 04 9D	250	1	1 ~ 230	50	0.2	838	4	2 × 440	1 × 440	1320
NEAX 2502 08 9D	250	2	1 ~ 230	100	0.5	1677	5	2 × 730	1 × 730	2190
NEAX 2503 12 9D	250	3	1 ~ 230	150	0.7	2514	6	2 × 1030	1 × 1030	3090
NEAX 2504 16 9D	250	4	1 ~ 230	200	0.9	3353	7	2 × 1310	1 × 1310	3930
NEAX 2505 20 9D	250	5	1 ~ 230	250	1.2	4190	9	2 × 1600	1 × 1600	4800
NEAX 2506 24 9D	250	6	1 ~ 230	300	1.4	5027	10	2 × 1890	1 × 1890	5670
NEAX 3001 06 9D	300	1	1 ~ 230	72	0.3	1411	6	3 × 440	1 × 440	1760
NEAX 3002 10 9D	300	2	1 ~ 230	144	0.6	2824	7	3 × 730	1 × 730	2920
NEAX 3003 16 9D	300	3	1 ~ 230	216	1.0	4240	9	3 × 1030	1 × 1030	4120
NEAX 3004 21 9D	300	4	1 ~ 230	288	1.3	5649	11	3 × 1310	1 × 1310	5240
NEAX 3005 27 9D	300	5	1 ~ 230	360	1.6	7059	13	3 × 1600	1 × 1600	6400
NEAX 3006 31 9D	300	6	1 ~ 230	432	1.9	8474	15	3 × 1890	1 × 1890	7560
NEAX 3501 07 9D	350	1	1 ~ 230	130	0.6	2084	11	4 × 440	2 × 440	2640
NEAX 3502 13 9D	350	2	1 ~ 230	260	1.2	4165	14	4 × 730	2 × 730	4380
NEAX 3503 20 9D	350	3	1 ~ 230	390	1.7	6264	17	4 × 1030	2 × 1030	6180
NEAX 3504 27 9D	350	4	1 ~ 230	520	2.3	8336	20	4 × 1310	2 × 1310	7860
NEAX 3505 34 9D	350	5	1 ~ 230	650	2.9	10411	22	4 × 1600	2 × 1600	9600
NEAX 3506 40 9D	350	6	1 ~ 230	780	3.5	12516	24	4 × 1890	2 × 1890	11340
NEAX 4001 09 9D	400	1	1 ~ 230	160	0.7	3434	11	4 × 550	1 × 550	2750
NEAX 4002 18 9D	400	2	1 ~ 230	320	1.5	6821	14	4 × 1030	1 × 1030	5150
NEAX 4003 24 9D	400	3	1 ~ 230	480	2.2	9827	16	4 × 1310	1 × 1310	6550
NEAX 4004 36 9D	400	4	1 ~ 230	640	2.9	13639	20	4 × 1890	1 × 1890	9450
NEAX 4501 14 9D	450	1	3 ~ 400	460	1.0	5904	15	4 × 730	1 × 730	3650
NEAX 4502 28 9D	450	2	3 ~ 400	920	1.9	11811	18	4 × 1310	1 × 1310	6550
NEAX 4503 41 9D	450	3	3 ~ 400	1380	2.9	17696	22	4 × 1890	1 × 1890	9450
NEAX 4504 57 9D	450	4	3 ~ 400	1840	3.8	23625	24	4 × 2470	1 × 2470	12350
NEAX 5001 17 9D	500	1	3 ~ 400	820	1.6	8128	26	6 × 730	1 × 730	5110
NEAX 5001 26 9D	500	1	3 ~ 400	820	1.6	7486	23	7 × 730	2 × 730	6570
NEAX 5001 36 9D	500	1	3 ~ 400	820	1.6	6940	20	8 × 730	2 × 730	7300
NEAX 5002 36 9D	500	2	3 ~ 400	1640	3.2	16401	24	6 × 1400	1 × 1400	9800
NEAX 5002 54 9D	500	2	3 ~ 400	1640	3.2	15153	20	7 × 1400	2 × 1400	12600
NEAX 5002 75 9D	500	2	3 ~ 400	1640	3.2	14095	16	8 × 1400	2 × 1400	14000
NEAX 5003 54 9D	500	3	3 ~ 400	2460	4.8	24716	29	6 × 2050	1 × 2050	14350
NEAX 5003 82 9D	500	3	3 ~ 400	2460	4.8	22900	24	7 × 2050	2 × 2050	18450
NEAX 5003 114 9D	500	3	3 ~ 400	2460	4.8	21239	19	8 × 2050	2 × 2050	20500
NEAX 5004 76 9D	500	4	3 ~ 400	3280	6.4	32953	34	6 × 3390	1 × 3390	23730
NEAX 5004 114 9D	500	4	3 ~ 400	3280	6.4	30485	29	7 × 3390	2 × 3390	30510
NEAX 5004 152 9D	500	4	3 ~ 400	3280	6.4	28420	24	8 × 3390	2 × 3390	33900

FIN SPACING 4 mm, with electrical defrost. Rt>=0°C
SEPARACIÓN ALETAS 4 mm, con desescarche eléctrico. Rt>=0°C

Modelo / Model	Capacidad / Capacity R717 (kw)		Superficie / Surface (m ²)	Volumen interno / Tube Volume (dm ³)	Filas de serpentin / Coil Rows	Peso Neto / N.W. (kg)	Conexión / Connection (ømm)	
	te= -8°C	te= -25°C					Entrada / Inlet	Salida / Outlet
	DT1=8K	DT1=7K						
NEAX 5501 51 4D	14.3	9.86	50.9	8.6	4	121.1	DN20	DN25
NEAX 5501 76 4D	18.08	12.72	76.4	12.9	6	140.2	DN20	DN25
NEAX 5501 102 4D	20.05	14.44	101.9	17.1	8	163.9	DN25	DN32
NEAX 5502 105 4D	28.71	20.8	104.7	17.6	4	210.4	DN25	DN32
NEAX 5502 157 4D	36.91	25.69	157.1	26.4	6	247	DN32	DN40
NEAX 5502 210 4D	39.96	29.58	209.5	35.3	8	291.6	DN32	DN40
NEAX 5503 159 4D	44.03	30.05	158.6	26.7	4	298.3	DN32	DN40
NEAX 5503 238 4D	55.29	39.96	237.8	40	6	354.6	DN40	DN50
NEAX 5503 317 4D	61.9	44.3	317.1	53.4	8	418.5	DN40	DN50
NEAX 5504 212 4D	58.03	42.01	212.4	35.7	4	388	DN40	DN50
NEAX 5504 319 4D	72.97	53.19	318.5	53.6	6	462.8	DN40	DN50
NEAX 5504 425 4D	80.75	59.83	424.7	71.5	8	549.2	DN50	DN65
NEAX 6301 73 4D	13	11.32	72.5	12.2	4	163.9	DN25	DN32
NEAX 6301 109 4D	20.86	16.53	108.8	18.3	6	189.6	DN25	DN32
NEAX 6301 145 4D	25.88	19.41	145.1	24.4	8	220.5	DN25	DN32
NEAX 6301 181 4D	29.07	20.04	181.4	30.5	10	252.4	DN25	DN32
NEAX 6302 149 4D	36.73	27.36	148.5	25	4	288.1	DN32	DN40
NEAX 6302 223 4D	42.7	33.7	222.7	37.5	6	341.4	DN40	DN50
NEAX 6302 297 4D	52.84	39.53	297	50	8	399.1	DN40	DN50
NEAX 6302 371 4D	58.58	42.22	371.2	62.5	10	456.8	DN40	DN50
NEAX 6303 224 4D	50.49	39.95	224.4	37.8	4	414.8	DN40	DN50
NEAX 6303 337 4D	72.32	52.74	336.6	56.7	6	490.2	DN50	DN65
NEAX 6303 449 4D	73.33	57.55	448.8	75.6	8	582.5	2×DN40	2×DN50
NEAX 6303 561 4D	88.55	59.69	561.1	94.4	10	660.4	2×DN40	2×DN50
NEAX 6304 300 4D	74.26	55.29	300.4	50.6	4	539.2	DN50	DN65
NEAX 6304 451 4D	98.67	67.46	450.5	75.8	6	639.3	2×DN40	2×DN50
NEAX 6304 601 4D	106.74	79.78	600.7	101.1	8	754.4	2×DN40	2×DN50
NEAX 6304 751 4D	114.01	85.03	750.9	126.4	10	868.7	2×DN40	2×DN50
NEAX 8001 118 4D	28.01	21.58	117.5	19.8	4	241.9	DN25	DN32
NEAX 8001 176 4D	35.62	27.37	176.3	29.7	6	285.1	DN32	DN40
NEAX 8001 235 4D	42.61	31.26	235.1	39.6	8	335.6	DN40	DN50
NEAX 8001 294 4D	45.81	32.54	293.9	49.5	10	379	DN40	DN50
NEAX 8002 240 4D	61.03	44.01	239.8	40.4	4	430.6	DN40	DN50
NEAX 8002 360 4D	72.61	55.65	359.7	60.5	6	515.4	DN50	DN65
NEAX 8002 480 4D	86.81	63.63	479.6	80.7	8	613.6	DN50	DN65
NEAX 8002 600 4D	93.29	66.44	599.5	100.9	10	695	2×DN40	2×DN50
NEAX 8003 362 4D	86.32	66.3	362	60.9	4	621	DN50	DN65
NEAX 8003 543 4D	109.58	83.92	543	91.4	6	748.3	DN50	DN65
NEAX 8003 724 4D	122.97	94.62	724.1	121.9	8	894.9	2×DN40	2×DN50
NEAX 8003 905 4D	140.51	97.26	905.1	152.4	10	1001.8	2×DN50	2×DN65

Modelo / Model	Ventilador con Motor Axial / Axial Fans							Desescarche Eléctrico Electric Defrost		
	Diámetro / Diameter (ø mm)	Nº	Voltaje / Voltage (V, 50Hz)	Potencia / Power (W)	Intensidad / Current (A)	Flujo de aire / Air Flow (m3/h)	Tiro / Air Throw (m)	Aletas / Coil (W)	Desagüe / Drain Pan (W)	Total / Total (W)
NEAX 5501 51 4D	550	1	3 ~ 400	770	1.7	7862	16	4 × 1280	1 × 1280	6400
NEAX 5501 76 4D	550	1	3 ~ 400	770	1.7	7395	15	6 × 1280	2 × 1280	10240
NEAX 5501 102 4D	550	1	3 ~ 400	770	1.7	6900	14	8 × 1280	2 × 1280	12800
NEAX 5502 105 4D	550	2	3 ~ 400	1540	3.3	15818	19	4 × 2320	1 × 2320	11600
NEAX 5502 157 4D	550	2	3 ~ 400	1540	3.3	14928	18	6 × 2320	2 × 2320	18560
NEAX 5502 210 4D	550	2	3 ~ 400	1540	3.3	13967	17	8 × 2320	2 × 2320	23200
NEAX 5503 159 4D	550	3	3 ~ 400	2310	5.0	23761	22	4 × 3200	1 × 3200	16000
NEAX 5503 238 4D	550	3	3 ~ 400	2310	5.0	22452	21	6 × 3200	2 × 3200	25600
NEAX 5503 317 4D	550	3	3 ~ 400	2310	5.0	21023	20	8 × 3200	2 × 3200	32000
NEAX 5504 212 4D	550	4	3 ~ 400	3080	6.6	31722	28	4 × 4260	1 × 4260	21300
NEAX 5504 319 4D	550	4	3 ~ 400	3080	6.6	29975	26	6 × 4260	2 × 4260	34080
NEAX 5504 425 4D	550	4	3 ~ 400	3080	6.6	28093	24	8 × 4260	2 × 4260	42600
NEAX 6301 73 4D	630	1	3 ~ 400	1100	2.2	11739	19	5 × 1510	1 × 1510	9060
NEAX 6301 109 4D	630	1	3 ~ 400	1100	2.2	10982	18	7 × 1510	2 × 1510	13590
NEAX 6301 145 4D	630	1	3 ~ 400	1100	2.2	10341	17	9 × 1510	2 × 1510	16610
NEAX 6301 181 4D	630	1	3 ~ 400	1100	2.2	9841	16	12 × 1510	2 × 1510	21140
NEAX 6302 149 4D	630	2	3 ~ 400	2200	4.4	23486	22	5 × 2740	1 × 2740	16440
NEAX 6302 223 4D	630	2	3 ~ 400	2200	4.4	22115	21	7 × 2740	2 × 2740	24660
NEAX 6302 297 4D	630	2	3 ~ 400	2200	4.4	20854	20	9 × 2740	2 × 2740	30140
NEAX 6302 371 4D	630	2	3 ~ 400	2200	4.4	19861	19	12 × 2740	2 × 2740	38360
NEAX 6303 224 4D	630	3	3 ~ 400	3300	6.6	35320	28	5 × 3800	1 × 3800	22800
NEAX 6303 337 4D	630	3	3 ~ 400	3300	6.6	33199	26	7 × 3800	2 × 3800	34200
NEAX 6303 449 4D	630	3	3 ~ 400	3300	6.6	31395	24	9 × 3800	2 × 3800	41800
NEAX 6303 561 4D	630	3	3 ~ 400	3300	6.6	29867	22	12 × 3800	2 × 3800	53200
NEAX 6304 300 4D	630	4	3 ~ 400	4400	8.8	47078	33	5 × 5060	1 × 5060	30360
NEAX 6304 451 4D	630	4	3 ~ 400	4400	8.8	44293	31	7 × 5060	2 × 5060	45540
NEAX 6304 601 4D	630	4	3 ~ 400	4400	8.8	41876	29	9 × 5060	2 × 5060	55660
NEAX 6304 751 4D	630	4	3 ~ 400	4400	8.8	39905	27	12 × 5060	2 × 5060	70840
NEAX 8001 118 4D	800	1	3 ~ 400	1600	3.5	18885	25	7 × 1700	1 × 1700	13600
NEAX 8001 176 4D	800	1	3 ~ 400	1600	3.5	17654	23	10 × 1700	2 × 1700	20400
NEAX 8001 235 4D	800	1	3 ~ 400	1600	3.5	16401	21	16 × 1700	2 × 1700	30600
NEAX 8001 294 4D	800	1	3 ~ 400	1600	3.5	15331	19	16 × 1700	2 × 1700	30600
NEAX 8002 240 4D	800	2	3 ~ 400	3200	7.0	37917	29	7 × 2810	1 × 2810	22480
NEAX 8002 360 4D	800	2	3 ~ 400	3200	7.0	35521	27	10 × 2810	2 × 2810	33720
NEAX 8002 480 4D	800	2	3 ~ 400	3200	7.0	33103	25	16 × 2810	2 × 2810	50580
NEAX 8002 600 4D	800	2	3 ~ 400	3200	7.0	30982	23	16 × 2810	2 × 2810	50580
NEAX 8003 362 4D	800	3	3 ~ 400	4800	10.5	57027	34	7 × 4420	1 × 4420	35360
NEAX 8003 543 4D	800	3	3 ~ 400	4800	10.5	53379	32	10 × 4420	2 × 4420	53040
NEAX 8003 724 4D	800	3	3 ~ 400	4800	10.5	49848	30	16 × 4420	2 × 4420	79560
NEAX 8003 905 4D	800	3	3 ~ 400	4800	10.5	46626	28	16 × 4420	2 × 4420	79560

FIN SPACING 6 mm, with electrical defrost. Rt>=-18°C
SEPARACIÓN ALETAS 6 mm, con desescarche eléctrico. Rt>=-18°C

Modelo / Model	Capacidad / Capacity R717 (kw)		Superficie / Surface (m ²)	Volumen interno / Tube Volume (dm ³)	Filas de serpentin / Coil Rows	Peso Neto / N.W. (kg)	Conexión / Connection (ømm)	
	te= -8°C	te= -25°C					Entrada / Inlet	Salida / Outlet
	DT1=8K	DT1=7K						
NEAX 5501 35 6D	11.88	8.34	35	8.6	4	119.1	DN20	DN25
NEAX 5501 53 6D	15.87	11.13	52.6	12.9	6	137.1	DN20	DN25
NEAX 5501 70 6D	18.18	13.13	70.1	17.1	8	159.8	DN25	DN32
NEAX 5502 72 6D	23.52	17.12	72	17.6	4	206.3	DN25	DN32
NEAX 5502 108 6D	32.04	22.58	108.1	26.4	6	240.9	DN32	DN40
NEAX 5502 144 6D	35.91	26.42	144.1	35.3	8	283.4	DN32	DN40
NEAX 5503 109 6D	36.69	25.57	109.1	26.7	4	292.2	DN32	DN40
NEAX 5503 164 6D	47.5	34.45	163.6	40	6	345.5	DN40	DN50
NEAX 5503 218 6D	56.29	40.33	218.1	53.4	8	406.3	DN40	DN50
NEAX 5504 146 6D	47.54	34.58	146.1	35.7	4	379.8	DN40	DN50
NEAX 5504 219 6D	62.49	45.59	219.1	53.6	6	450.6	DN40	DN50
NEAX 5504 292 6D	72.59	53.4	292.1	71.5	8	532.8	DN50	DN65
NEAX 6301 50 6D	10.35	9.02	49.9	12.2	4	161	DN25	DN32
NEAX 6301 75 6D	17.57	13.99	74.8	18.3	6	185.4	DN25	DN32
NEAX 6301 100 6D	22.87	17.28	99.8	24.4	8	214.8	DN25	DN32
NEAX 6301 125 6D	26.95	18.73	124.7	30.5	10	245.3	DN25	DN32
NEAX 6302 102 6D	29.99	22.51	102.1	25	4	282.3	DN32	DN40
NEAX 6302 153 6D	35.98	28.53	153.2	37.5	6	332.8	DN40	DN50
NEAX 6302 204 6D	46.69	35.2	204.3	50	8	387.6	DN40	DN50
NEAX 6302 255 6D	53.72	39.11	255.3	62.5	10	442.4	DN40	DN50
NEAX 6303 154 6D	40.81	32.37	154.4	37.8	4	406.3	DN40	DN50
NEAX 6303 232 6D	61.86	45.55	231.5	56.7	6	477.3	DN50	DN65
NEAX 6303 309 6D	64.05	50.59	308.7	75.6	8	565.3	2×DN40	2×DN50
NEAX 6303 386 6D	82.66	56.23	385.9	94.4	10	638.9	2×DN40	2×DN50
NEAX 6304 207 6D	60.59	45.46	206.6	50.6	4	527.7	DN50	DN65
NEAX 6304 310 6D	85.66	59.55	309.9	75.8	6	622	2×DN40	2×DN50
NEAX 6304 413 6D	94.32	71.03	413.2	101.1	8	731.5	2×DN40	2×DN50
NEAX 6304 517 6D	103.66	78.05	516.5	126.4	10	840	2×DN40	2×DN50
NEAX 8001 81 6D	22.85	17.7	80.9	19.8	4	237.3	DN25	DN32
NEAX 8001 121 6D	30.19	23.37	121.3	29.7	6	278.1	DN32	DN40
NEAX 8001 162 6D	38.24	28.16	161.7	39.6	8	326.4	DN40	DN50
NEAX 8001 202 6D	42.85	30.63	202.1	49.5	10	367.5	DN40	DN50
NEAX 8002 165 6D	50.37	36.78	164.9	40.4	4	421.3	DN40	DN50
NEAX 8002 247 6D	61.53	47.53	247.4	60.5	6	501.5	DN50	DN65
NEAX 8002 330 6D	77.84	57.2	329.9	80.7	8	594.9	DN50	DN65
NEAX 8002 412 6D	87.24	62.34	412.3	100.9	10	671.7	2×DN40	2×DN50
NEAX 8003 249 6D	70.36	54.31	249	60.9	4	607.2	DN50	DN65
NEAX 8003 374 6D	92.88	71.69	373.5	91.4	6	727.6	DN50	DN65
NEAX 8003 498 6D	108.97	83.9	498	121.9	8	867.2	2×DN40	2×DN50
NEAX 8003 623 6D	132.37	91.93	622.5	152.4	10	967.2	2×DN50	2×DN65

Modelo / Model	Ventilador con Motor Axial / Axial Fans							Desescarche Eléctrico Electric Defrost		
	Diámetro / Diameter (ø mm)	Nº	Voltaje / Voltage (V, 50Hz)	Potencia / Power (W)	Intensidad / Current (A)	Flujo de aire / Air Flow (m3/h)	Tiro / Air Throw (m)	Aletas / Coil (W)	Desagüe / Drain Pan (W)	Total / Total (W)
NEAX 5501 35 6D	550	1	3 ~ 400	770	1.7	8065	17	4 × 1280	1 × 1280	6400
NEAX 5501 53 6D	550	1	3 ~ 400	770	1.7	7659	16	6 × 1280	2 × 1280	10240
NEAX 5501 70 6D	550	1	3 ~ 400	770	1.7	7269	15	8 × 1280	2 × 1280	12800
NEAX 5502 72 6D	550	2	3 ~ 400	1540	3.3	16220	20	4 × 2320	1 × 2320	11600
NEAX 5502 108 6D	550	2	3 ~ 400	1540	3.3	15416	19	6 × 2320	2 × 2320	18560
NEAX 5502 144 6D	550	2	3 ~ 400	1540	3.3	14698	18	8 × 2320	2 × 2320	23200
NEAX 5503 109 6D	550	3	3 ~ 400	2310	5.0	24358	23	4 × 3200	1 × 3200	16000
NEAX 5503 164 6D	550	3	3 ~ 400	2310	5.0	23179	22	6 × 3200	2 × 3200	25600
NEAX 5503 218 6D	550	3	3 ~ 400	2310	5.0	22113	21	8 × 3200	2 × 3200	32000
NEAX 5504 146 6D	550	4	3 ~ 400	3080	6.6	32518	27	4 × 4260	1 × 4260	21300
NEAX 5504 219 6D	550	4	3 ~ 400	3080	6.6	30941	26	6 × 4260	2 × 4260	34080
NEAX 5504 292 6D	550	4	3 ~ 400	3080	6.6	29548	25	8 × 4260	2 × 4260	42600
NEAX 6301 50 6D	630	1	3 ~ 400	1100	2.2	12032	20	5 × 1510	1 × 1510	9060
NEAX 6301 75 6D	630	1	3 ~ 400	1100	2.2	11387	19	7 × 1510	2 × 1510	13590
NEAX 6301 100 6D	630	1	3 ~ 400	1100	2.2	10812	18	9 × 1510	2 × 1510	16610
NEAX 6301 125 6D	630	1	3 ~ 400	1100	2.2	10309	17	12 × 1510	2 × 1510	21140
NEAX 6302 102 6D	630	2	3 ~ 400	2200	4.4	24057	23	5 × 2740	1 × 2740	16440
NEAX 6302 153 6D	630	2	3 ~ 400	2200	4.4	22899	22	7 × 2740	2 × 2740	24660
NEAX 6302 204 6D	630	2	3 ~ 400	2200	4.4	21782	21	9 × 2740	2 × 2740	30140
NEAX 6302 255 6D	630	2	3 ~ 400	2200	4.4	20799	20	12 × 2740	2 × 2740	38360
NEAX 6303 154 6D	630	3	3 ~ 400	3300	6.6	36142	27	5 × 3800	1 × 3800	22800
NEAX 6303 232 6D	630	3	3 ~ 400	3300	6.6	34359	26	7 × 3800	2 × 3800	34200
NEAX 6303 309 6D	630	3	3 ~ 400	3300	6.6	32788	25	9 × 3800	2 × 3800	41800
NEAX 6303 386 6D	630	3	3 ~ 400	3300	6.6	31268	24	12 × 3800	2 × 3800	53200
NEAX 6304 207 6D	630	4	3 ~ 400	4400	8.8	48175	34	5 × 5060	1 × 5060	30360
NEAX 6304 310 6D	630	4	3 ~ 400	4400	8.8	45828	32	7 × 5060	2 × 5060	45540
NEAX 6304 413 6D	630	4	3 ~ 400	4400	8.8	43719	30	9 × 5060	2 × 5060	55660
NEAX 6304 517 6D	630	4	3 ~ 400	4400	8.8	41786	28	12 × 5060	2 × 5060	70840
NEAX 8001 81 6D	800	1	3 ~ 400	1600	3.5	19485	25	7 × 1700	1 × 1700	13600
NEAX 8001 121 6D	800	1	3 ~ 400	1600	3.5	18298	24	10 × 1700	2 × 1700	20400
NEAX 8001 162 6D	800	1	3 ~ 400	1600	3.5	17370	23	16 × 1700	2 × 1700	30600
NEAX 8001 202 6D	800	1	3 ~ 400	1600	3.5	16346	22	16 × 1700	2 × 1700	30600
NEAX 8002 165 6D	800	2	3 ~ 400	3200	7.0	39088	29	7 × 2810	1 × 2810	22480
NEAX 8002 247 6D	800	2	3 ~ 400	3200	7.0	36784	28	10 × 2810	2 × 2810	33720
NEAX 8002 330 6D	800	2	3 ~ 400	3200	7.0	34983	27	16 × 2810	2 × 2810	50580
NEAX 8002 412 6D	800	2	3 ~ 400	3200	7.0	32995	26	16 × 2810	2 × 2810	50580
NEAX 8003 249 6D	800	3	3 ~ 400	4800	10.5	58759	34	7 × 4420	1 × 4420	35360
NEAX 8003 374 6D	800	3	3 ~ 400	4800	10.5	55273	33	10 × 4420	2 × 4420	53040
NEAX 8003 498 6D	800	3	3 ~ 400	4800	10.5	52627	32	16 × 4420	2 × 4420	79560
NEAX 8003 623 6D	800	3	3 ~ 400	4800	10.5	49629	31	16 × 4420	2 × 4420	79560

FIN SPACING 9 mm, with electrical defrost. Rt>=-35°C
SEPARACIÓN ALETAS 9 mm, con desescarche eléctrico. Rt>=-35°C

Modelo / Model	Capacidad / Capacity R717 (kw)		Superficie / Surface (m ²)	Volumen interno / Tube Volume (dm ³)	Filas de serpentin / Coil Rows	Peso Neto / N.W. (kg)	Conexión / Connection (ømm)	
	te= -8°C	te= -25°C					Entrada / Inlet	Salida / Outlet
	DT1=8K	DT1=7K						
NEAX 5501 24 9D	9.51	6.78	24.4	8.6	4	116.5	DN20	DN25
NEAX 5501 37 9D	13	9.33	36.7	12.9	6	133.3	DN20	DN25
NEAX 5501 49 9D	15.68	11.33	48.9	17.1	8	154.7	DN25	DN32
NEAX 5502 50 9D	30.67	22.48	100.5	35.3	4	201.1	DN25	DN32
NEAX 5502 75 9D	18.64	13.61	50.2	17.6	6	233.2	DN32	DN40
NEAX 5502 101 9D	26.66	19.03	75.4	26.4	8	273.1	DN32	DN40
NEAX 5503 76 9D	29.45	20.89	76.1	26.7	4	284.6	DN32	DN40
NEAX 5503 114 9D	39.16	28.51	114.1	40	6	334	DN40	DN50
NEAX 5503 152 9D	48.53	34.95	152.1	53.4	8	391	DN40	DN50
NEAX 5504 102 9D	37.66	27.47	101.9	35.7	4	369.6	DN40	DN50
NEAX 5504 153 9D	51.4	37.55	152.8	53.6	6	435.3	DN40	DN50
NEAX 5504 204 9D	61.94	45.43	203.7	71.5	8	512.5	DN50	DN65
NEAX 6301 35 9D	8.01	6.99	34.8	12.2	4	157.4	DN25	DN32
NEAX 6301 52 9D	14.28	11.4	52.2	18.3	6	179.9	DN25	DN32
NEAX 6301 70 9D	19.36	14.7	69.6	24.4	8	207.5	DN25	DN32
NEAX 6301 87 9D	23.91	16.83	87	30.5	10	236.2	DN25	DN32
NEAX 6302 71 9D	23.59	17.83	71.2	25	4	275.1	DN32	DN40
NEAX 6302 107 9D	29.23	23.24	106.8	37.5	6	321.9	DN40	DN50
NEAX 6302 143 9D	39.53	29.93	142.5	50	8	373.1	DN40	DN50
NEAX 6302 178 9D	47.17	34.62	178.1	62.5	10	424.4	DN40	DN50
NEAX 6303 108 9D	31.91	25.34	107.7	37.8	4	395.5	DN40	DN50
NEAX 6303 162 9D	50.78	37.7	161.5	56.7	6	461.2	DN50	DN65
NEAX 6303 215 9D	53.75	42.59	215.3	75.6	8	543.8	2×DN40	2×DN50
NEAX 6303 269 9D	73.83	50.89	269.2	94.4	10	612	2×DN40	2×DN50
NEAX 6304 144 9D	47.66	35.98	144.1	50.6	4	513.2	DN50	DN65
NEAX 6304 216 9D	71.19	50.27	216.1	75.8	6	600.4	2×DN40	2×DN50
NEAX 6304 288 9D	79.82	60.39	288.2	101.1	8	702.6	2×DN40	2×DN50
NEAX 6304 360 9D	90.39	68.46	360.2	126.4	10	803.9	2×DN40	2×DN50
NEAX 8001 56 9D	18.02	14.01	56.4	19.8	4	231.4	DN25	DN32
NEAX 8001 85 9D	24.69	19.21	84.6	29.7	6	269.3	DN32	DN40
NEAX 8001 113 9D	32.54	24.13	112.8	39.6	8	314.7	DN40	DN50
NEAX 8001 141 9D	38.21	27.45	141	49.5	10	352.8	DN40	DN50
NEAX 8002 115 9D	40.03	29.54	115	40.4	4	409.7	DN40	DN50
NEAX 8002 173 9D	50.35	39.06	172.5	60.5	6	484.1	DN50	DN65
NEAX 8002 230 9D	66.19	49.02	230.1	80.7	8	571.7	DN50	DN65
NEAX 8002 288 9D	77.75	55.75	287.6	100.9	10	642.7	2×DN40	2×DN50
NEAX 8003 174 9D	55.43	42.96	173.7	60.9	4	589.7	DN50	DN65
NEAX 8003 261 9D	75.99	58.91	260.5	91.4	6	701.4	DN50	DN65
NEAX 8003 347 9D	91.87	71.1	347.4	121.9	8	832.4	2×DN40	2×DN50
NEAX 8003 434 9D	118.79	82.86	434.2	152.4	10	923.7	2×DN50	2×DN65

Modelo / Model	Ventilador con Motor Axial / Axial Fans							Desescarche Eléctrico Electric Defrost		
	Diámetro / Diameter (ø mm)	Nº	Voltaje / Voltage (V, 50Hz)	Potencia / Power (W)	Intensidad / Current (A)	Flujo de aire / Air Flow (m3/h)	Tiro / Air Throw (m)	Aletas / Coil (W)	Desagüe / Drain Pan (W)	Total / Total (W)
NEAX 5501 24 9D	550	1	3 ~ 400	770	1.7	8257	17	4 × 1280	1 × 1280	6400
NEAX 5501 37 9D	550	1	3 ~ 400	770	1.7	7884	16	6 × 1280	2 × 1280	10240
NEAX 5501 49 9D	550	1	3 ~ 400	770	1.7	7581	16	8 × 1280	2 × 1280	12800
NEAX 5502 50 9D	550	2	3 ~ 400	1540	3.3	16586	21	4 × 2320	1 × 2320	11600
NEAX 5502 75 9D	550	2	3 ~ 400	1540	3.3	15857	20	6 × 2320	2 × 2320	18560
NEAX 5502 101 9D	550	2	3 ~ 400	1540	3.3	15254	19	8 × 2320	2 × 2320	23200
NEAX 5503 76 9D	550	3	3 ~ 400	2310	5.0	24903	24	4 × 3200	1 × 3200	16000
NEAX 5503 114 9D	550	3	3 ~ 400	2310	5.0	23827	23	6 × 3200	2 × 3200	25600
NEAX 5503 152 9D	550	3	3 ~ 400	2310	5.0	22936	22	8 × 3200	2 × 3200	32000
NEAX 5504 102 9D	550	4	3 ~ 400	3080	6.6	33241	28	4 × 4260	1 × 4260	21300
NEAX 5504 153 9D	550	4	3 ~ 400	3080	6.6	31791	27	6 × 4260	2 × 4260	34080
NEAX 5504 204 9D	550	4	3 ~ 400	3080	6.6	30609	26	8 × 4260	2 × 4260	42600
NEAX 6301 35 9D	630	1	3 ~ 400	1100	2.2	12214	20	5 × 1510	1 × 1510	9060
NEAX 6301 52 9D	630	1	3 ~ 400	1100	2.2	11733	19	7 × 1510	2 × 1510	13590
NEAX 6301 70 9D	630	1	3 ~ 400	1100	2.2	11242	19	9 × 1510	2 × 1510	16610
NEAX 6301 87 9D	630	1	3 ~ 400	1100	2.2	10778	18	12 × 1510	2 × 1510	21140
NEAX 6302 71 9D	630	2	3 ~ 400	2200	4.4	24416	24	5 × 2740	1 × 2740	16440
NEAX 6302 107 9D	630	2	3 ~ 400	2200	4.4	23572	23	7 × 2740	2 × 2740	24660
NEAX 6302 143 9D	630	2	3 ~ 400	2200	4.4	22616	22	9 × 2740	2 × 2740	30140
NEAX 6302 178 9D	630	2	3 ~ 400	2200	4.4	21727	21	12 × 2740	2 × 2740	38360
NEAX 6303 108 9D	630	3	3 ~ 400	3300	6.6	36673	28	5 × 3800	1 × 3800	22800
NEAX 6303 162 9D	630	3	3 ~ 400	3300	6.6	35358	27	7 × 3800	2 × 3800	34200
NEAX 6303 215 9D	630	3	3 ~ 400	3300	6.6	34027	26	9 × 3800	2 × 3800	41800
NEAX 6303 269 9D	630	3	3 ~ 400	3300	6.6	32648	25	12 × 3800	2 × 3800	53200
NEAX 6304 144 9D	630	4	3 ~ 400	4400	8.8	48882	35	5 × 5060	1 × 5060	30360
NEAX 6304 216 9D	630	4	3 ~ 400	4400	8.8	47152	33	7 × 5060	2 × 5060	45540
NEAX 6304 288 9D	630	4	3 ~ 400	4400	8.8	45359	31	9 × 5060	2 × 5060	55660
NEAX 6304 360 9D	630	4	3 ~ 400	4400	8.8	43633	29	12 × 5060	2 × 5060	70840
NEAX 8001 56 9D	800	1	3 ~ 400	1600	3.5	19959	25	7 × 1700	1 × 1700	13600
NEAX 8001 85 9D	800	1	3 ~ 400	1600	3.5	18945	24	10 × 1700	2 × 1700	20400
NEAX 8001 113 9D	800	1	3 ~ 400	1600	3.5	18064	23	16 × 1700	2 × 1700	30600
NEAX 8001 141 9D	800	1	3 ~ 400	1600	3.5	17313	22	16 × 1700	2 × 1700	30600
NEAX 8002 115 9D	800	2	3 ~ 400	3200	7.0	40009	30	7 × 2810	1 × 2810	22480
NEAX 8002 173 9D	800	2	3 ~ 400	3200	7.0	38076	29	10 × 2810	2 × 2810	33720
NEAX 8002 230 9D	800	2	3 ~ 400	3200	7.0	36316	28	16 × 2810	2 × 2810	50580
NEAX 8002 288 9D	800	2	3 ~ 400	3200	7.0	34900	27	16 × 2810	2 × 2810	50580
NEAX 8003 174 9D	800	3	3 ~ 400	4800	10.5	60130	37	7 × 4420	1 × 4420	35360
NEAX 8003 261 9D	800	3	3 ~ 400	4800	10.5	57205	35	10 × 4420	2 × 4420	53040
NEAX 8003 347 9D	800	3	3 ~ 400	4800	10.5	54615	33	16 × 4420	2 × 4420	79560
NEAX 8003 434 9D	800	3	3 ~ 400	4800	10.5	52442	31	16 × 4420	2 × 4420	79560

AVAILABLE OPTIONS FOR NEAX SERIES

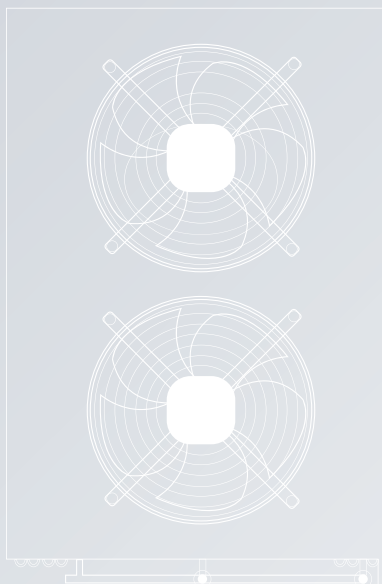
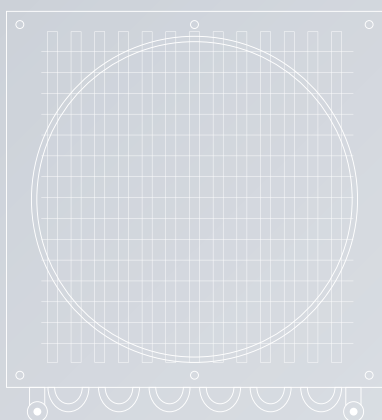
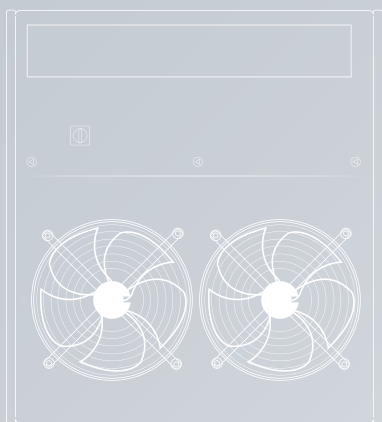
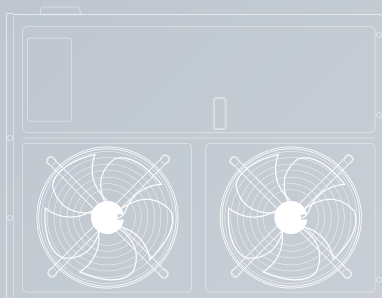

Defrost options:

- Air
- Electrical defrost
- Hot gas
- Water
- Hot gas for coil and electrical for tray
- Water and electrical



Tube material options:

- Stainless steel AISI SUS304



Coil protection options:

- Aluminium fins
- Fins with GOLDFIN anti-corrosion high resistance coating



Fan options:

- EC Fans
- Silica gel heaters for fan nozzles, only for $\varnothing 500$ mm or above
- Streamers: Airk-guiding device for increased airthrow



Casing options:

- White powder-coated painted aluminium
- Stainless steel AISI SUS304



Other options:

- Double insulated drip tray (recommended for low temperature applications)
- Thermal protector for defrosting electrical heaters

OPCIONES DISPONIBLES PARA LA SERIE NEAX



Opciones de desescarche:

- Aire
- Desescarche eléctrico
- Gas caliente
- Agua
- Aas caliente en serpentín y eléctrico en bandeja
- Agua y eléctrico



Tube material options:

- Acero inoxidable AISI SUS304



Coil protection options:

- Aleta de aluminio
- Aleta con tratamiento GOLDFIN con anticorrosión de alta resistencia



Fan options:

- Ventiladores EC
- Resistencias calefactoras para aro de ventiladores, sólo para modelos $\varnothing 500$ mm o más grandes
- Streamers: Dispositivo de aire guiado para incrementar el tiro de aire



Casing options:

- Aluminio pintado al polvo blanco
- acero inoxidable AISI SUS304



Other options:

- Bandeja de goteo con doble aislamiento (recomendada en aplicaciones con cámaras de baja temperatura)
- Protector térmico para resistencias de desescarche

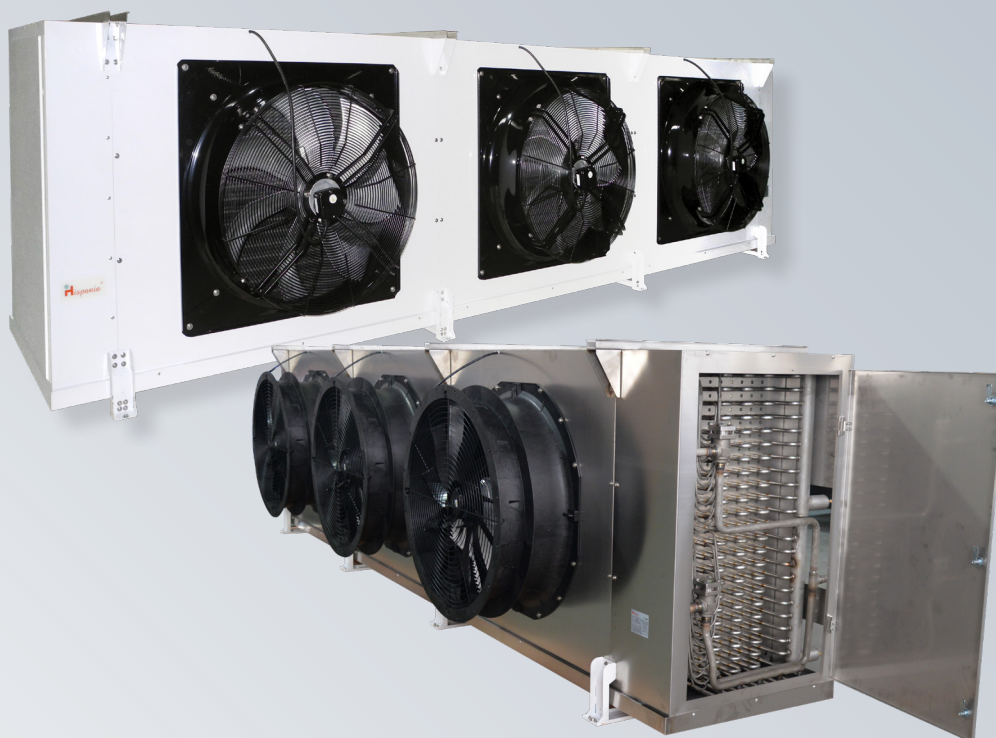

NEBX SERIES EVAPORATOR

EVAPORADORES SERIE NEBX

INDUSTRIAL CUBIC EVAPORATORS EVAPORADORES CUBICOS INDUSTRIALES

The NEBX range of industrial cubic evaporators has been designed for use in big cold rooms for the preservation of fresh and frozen products.

The exchange coils used in the NEBX range are highly

The exchange coils used in the NEBX range are built with a geometry of recognized high efficiency, with special profile aluminum fins and ø15 mm high quality SS304 tubes, with high heat transfer coefficient. They are supplied clean and tested under a pressure of 30 bar.

01

White powder-coated aluminium casing with high resistance to corrosion and impacts.

02

In models with electric defrost, stainless steel electric heaters covered by aluminum tubes are used, located in the finned package to avoid steam problems and make easy replacement.

03

The electrical parts are connected to an earth terminal, inside a connection box with access holes equipped with cable glands with IP 65 protection.

04

For performance at work points other than those in this catalog, use the "Unit Selector Hybrid HISPANIA" software.



For special applications and additional information consult our Technical Department.

NEBX SERIES EVAPORATORS EVAPORADORES SERIE NEBX

La gama de evaporadores cúbicos industriales NEBX ha sido diseñada para su uso en grandes cámaras frigoríficas de conservación de productos frescos y congelados.

Los baterías de intercambio utilizadas en la gama NEBX son

Los baterías de intercambio utilizadas en la gama NEBX están construidos con una geometría de reconocida alta eficiencia, con aletas de aluminio de perfil especial y tubos de SS304 de ø15 mm de alta calidad, con un alto coeficiente de transferencia de calor. Se suministran limpias y probadas a una presión de 30 bar.

01

La carcasa de aluminio pintado en blanco al polvo electrostático con alta resistencia a la corrosión y a los impactos.

02

En los modelos con desescarche eléctrico se usan resistencias en acero inoxidable cubiertas por tubos de aluminio, situados en el paquete aleteado para evitar problemas de vapor y facilitar la sustitución.

03

Las partes eléctricas están conectadas a un terminal de tierra, dentro de una caja de conexiones con orificios de acceso equipados con prensaestopas con grado de protección IP 65.

04

Para rendimientos en puntos de trabajo distintos a los de este catálogo utilizar el software "Unit Selector Hybrid HISPANIA".



Para aplicaciones especiales e informaciones adicionales consultar a nuestro Departamento Técnico.

NEBX 5002 69 7D S1 2 3

- Fin materials (blank: aluminum, 3: stainless steel, GF: golden fins) / Materiales de las aletas (en blanco: aluminio, 3: acero inoxidable, GF: aletas doradas)
- Casing materials (blank: aluminum, 2: stainless steel) / Materiales de la carcasa (en blanco: aluminio, 2: acero inoxidable)
- Tube materials (1: stainless steel) / Materiales del tubo (1: acero inoxidable)
- Defrost system (blank: air, D: electric, HG: hot gas, W: water, HGD: hot gas & electric, WD: water & electric) / Sistema de descongelación (en blanco: aire, D: eléctrico, HG: gas caliente, W: agua, HGD: gas caliente y eléctrico, WD: agua y electricidad)
- Fin spacing (mm) / Espacio entre aletas (mm)
- Surface (m²) / Superficie (m²)
- Fan number / Número de ventiladores
- Fan \varnothing (mm) / Ventilador \varnothing (mm)
- Series / Serie

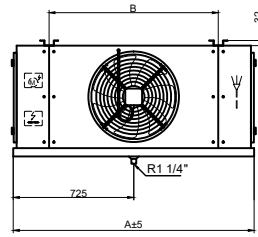
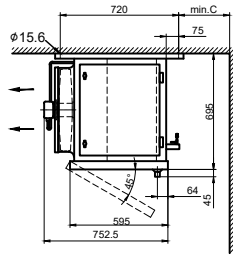

NEB/D 5001

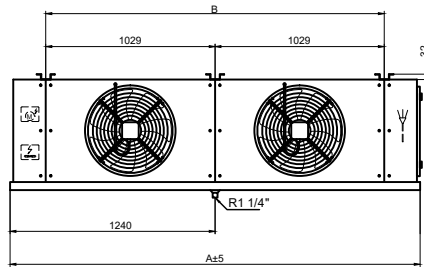

NEB/D 5002

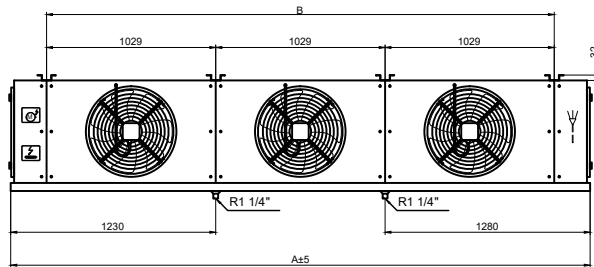

NEB/D 5003

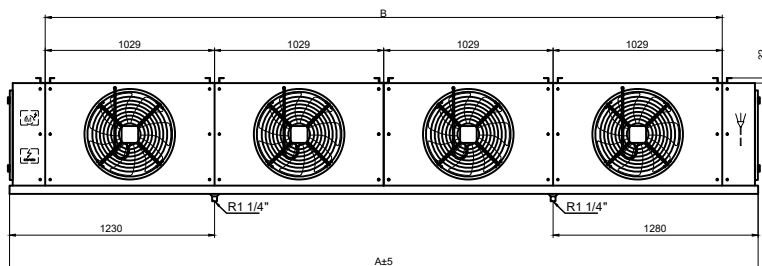

NEB/D 5004

Model / Model	Dimensions / dimensiones(mm)		
	A	B	C
NEAX 5001...	1500	1030	300
NEAX 5002...	2530	2060	400
NEAX 5003...	3560	3090	450
NEAX 5004...	4590	4120	490

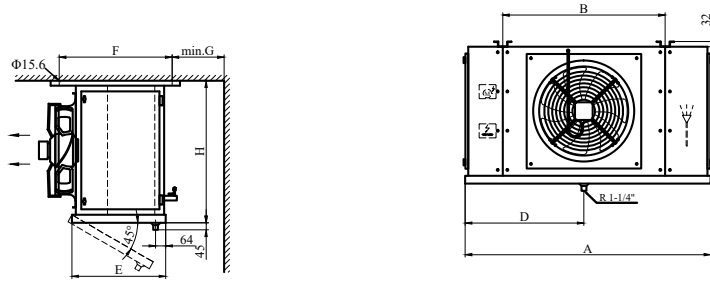

NEB
5501/6301/8001

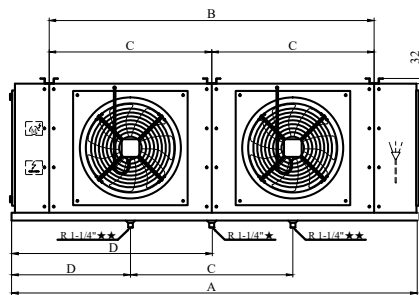

NEB
★5502
★★6302/8002

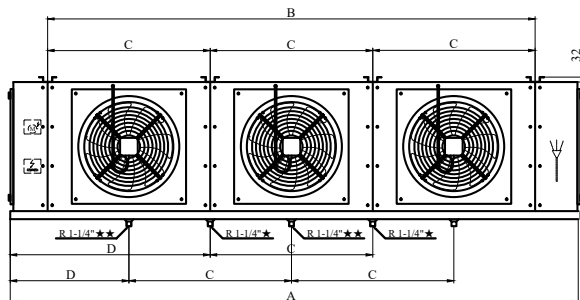

NEB
★5503
★★6303/8003

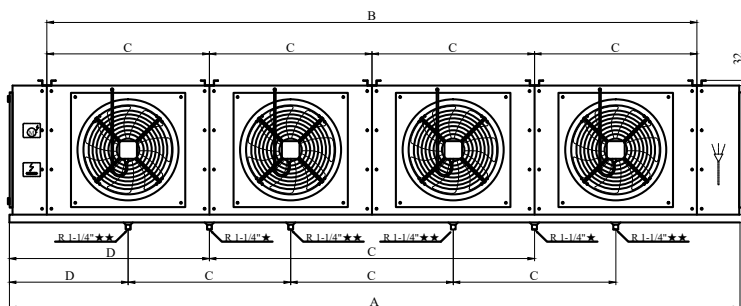

NEB
★5504
★★6304

Model / Model	Dimensions / dimensiones(mm)							
	A	B	C	D	E	F	G	H
NEBX 550(4 rows)...	1550	1030		750	620	730	260	900
NEBX 550(6 rows)...	1550	1030		750	635	745	260	900
NEBX 550(8 rows)...	1550	1030		750	735	845	260	900
NEBX 5502(4 rows)...	2580	2060	1030	1265	620	730	380	900
NEBX 5502(6 rows)...	2580	2060	1030	1265	635	745	380	900
NEBX 5502(8 rows)...	2580	2060	1030	1265	735	845	380	900
NEBX 5503(4 rows)...	3610	3090	1030	750	620	730	460	900
NEBX 5503(6 rows)...	3610	3090	1030	750	635	745	460	900
NEBX 5503(8 rows)...	3610	3090	1030	750	735	845	460	900
NEBX 5504(4 rows)...	4640	4120	1030	750	620	730	500	900
NEBX 5504(6 rows)...	4640	4120	1030	750	635	745	500	900
NEBX 5504(8 rows)...	4640	4120	1030	750	735	845	500	900
NEBX 630(4 rows)...	1750	1230		850	635	745	310	1000
NEBX 630(6 rows)...	1750	1230		850	680	790	310	1000
NEBX 630(8 rows)...	1750	1230		850	750	860	310	1000
NEBX 630(10 rows)...	1750	1230		850	850	960	310	1000
NEBX 6302(4 rows)...	2980	2460	1230	850	635	745	440	1000
NEBX 6302(6 rows)...	2980	2460	1230	850	680	790	440	1000
NEBX 6302(8 rows)...	2980	2460	1230	850	750	860	440	1000
NEBX 6302(10 rows)...	2980	2460	1230	850	850	960	440	1000
NEBX 6303(4 rows)...	4210	3690	1230	850	635	745	530	1000
NEBX 6303(6 rows)...	4210	3690	1230	850	680	790	530	1000
NEBX 6303(8 rows)...	4210	3690	1230	850	750	860	530	1000
NEBX 6303(10 rows)...	4210	3690	1230	850	850	960	530	1000
NEBX 6304(4 rows)...	5440	4920	1230	850	635	745	580	1000
NEBX 6304(6 rows)...	5440	4920	1230	850	680	790	580	1000
NEBX 6304(8 rows)...	5440	4920	1230	850	750	860	580	1000
NEBX 6304(10 rows)...	5440	4920	1230	850	850	960	580	1000
NEBX 800(4 rows)...	1950	1430		950	650	760	390	1300
NEBX 800(6 rows)...	1950	1430		950	750	860	390	1300
NEBX 800(8 rows)...	1950	1430		950	810	920	390	1300
NEBX 800(10 rows)...	1950	1430		950	910	1020	390	1300
NEBX 8002(4 rows)...	3380	2860	1430	950	650	760	580	1300
NEBX 8002(6 rows)...	3380	2860	1430	950	750	860	580	1300
NEBX 8002(8 rows)...	3380	2860	1430	950	810	920	580	1300
NEBX 8002(10 rows)...	3380	2860	1430	950	910	1020	580	1300
NEBX 8003(4 rows)...	4810	4290	1430	950	650	760	700	1300
NEBX 8003(6 rows)...	4810	4290	1430	950	750	860	700	1300
NEBX 8003(8 rows)...	4810	4290	1430	950	810	920	700	1300
NEBX 8003(10 rows)...	4810	4290	1430	950	910	1020	700	1300

FIN SPACING 4.5 mm, with electrical defrost. Rt>=0°C

SEPARACIÓN ALETAS 4.5 mm, con desescarche eléctrico. Rt>=0°C

Modelo / Model	Capacidad / Capacity R717 (kw)		Superficie / Surface (m ²)	Volumen interno / Tube Volume (dm ³)	Filas de serpentin / Coil Rows	Peso Neto / N.W. (kg)	Conexión / Connection (ømm)	
	te= -8°C	te= -25°C					Entrada / Inlet	Salida / Outlet
	DT1=8K	DT1=7K						
NEBX 5001 53 4.5D	8.81	6.92	50.5	6.9		103.4	DN15	DN20
NEBX 5001 79 4.5D	12.17	8.62	75.7	10.3		124.0	DN15	DN20
NEBX 5002 106 4.5D	19.09	13.87	103.8	14.2		180.1	DN25	DN32
NEBX 5002 159 4.5D	25.06	17.77	155.7	21.3		218.5	DN25	DN32
NEBX 5003 159 4.5D	28.95	20.31	157.1	21.5		257.0	DN25	DN32
NEBX 5003 239 4.5D	37.96	26.92	235.7	32.2		312.2	DN32	DN40
NEBX 5004 218 4.5D	38.7	28.13	210.5	28.7		333.5	DN32	DN40
NEBX 5004 327 4.5D	50.57	37.01	315.7	43.1		407.0	DN40	DN50
NEBX 5501 67 4.5D	11.57	8.43	67.4	9.2	4	132.3	DN15	DN20
NEBX 5501 103 4.5D	15.15	11.05	101.1	13.8	6	153.8	DN20	DN25
NEBX 5501 135 4.5D	17.48	12.83	134.7	18.4	8	182.6	DN20	DN25
NEBX 5502 139 4.5D	23.8	17.34	138.5	18.9	4	231.5	DN25	DN32
NEBX 5502 213 4.5D	31.09	22.67	207.8	28.4	6	272.4	DN25	DN32
NEBX 5502 277 4.5D	35.88	26.27	277.1	37.8	8	325.0	DN32	DN40
NEBX 5503 210 4.5D	34.66	22.29	209.7	28.6	4	329.4	DN32	DN40
NEBX 5503 323 4.5D	47.39	33.55	314.6	42.9	6	391.2	DN32	DN40
NEBX 5503 419 4.5D	53.86	35.7	419.4	57.3	8	466.0	DN40	DN50
NEBX 5504 281 4.5D	48.25	35.16	280.9	38.4	4	428.5	DN32	DN40
NEBX 5504 433 4.5D	61.74	40.26	421.3	57.5	6	508.8	DN40	DN50
NEBX 5504 562 4.5D	72.67	53.14	561.8	76.7	8	608.5	2×DN32	2×DN40

Modelo / Model	Ventilador con Motor Axial / Axial Fans							Desescarche Eléctrico Electric Defrost		
	Diámetro / Diameter (ø mm)	Nº	Voltaje / Voltage (V, 50Hz)	Potencia / Power (W)	Intensidad / Current (A)	Flujo de aire / Air Flow (m ³ /h)	Tiro / Air Throw (m)	Aletas / Coil (W)	Desagüe / Drain Pan (W)	Total / Total (W)
NEBX 5001 53 4.5D	500	1	3 ~ 400	650	1.2	6945	16	3 × 1280	2 × 1280	6400
NEBX 5001 79 4.5D	500	1	3 ~ 400	650	1.2	6412	15	4 × 1280	2 × 1280	7680
NEBX 5002 106 4.5D	500	2	3 ~ 400	1300	2.3	13957	19	3 × 2320	2 × 2320	11600
NEBX 5002 159 4.5D	500	2	3 ~ 400	1300	2.3	12960	18	4 × 2320	2 × 2320	13920
NEBX 5003 159 4.5D	500	3	3 ~ 400	1950	3.5	20941	23	3 × 3200	2 × 3200	16000
NEBX 5003 239 4.5D	500	3	3 ~ 400	1950	3.5	19506	22	4 × 3200	2 × 3200	19200
NEBX 5004 218 4.5D	500	4	3 ~ 400	2600	4.6	27949	27	3 × 4260	2 × 4260	21300
NEBX 5004 327 4.5D	500	4	3 ~ 400	2600	4.6	26061	26	4 × 4260	2 × 4260	25560
NEBX 5501 67 4.5D	550	1	3 ~ 400	770	1.7	8046	15	4 × 1280	2 × 1280	7680
NEBX 5501 103 4.5D	550	1	3 ~ 400	770	1.7	7628	15	5 × 1280	2 × 1280	8960
NEBX 5501 135 4.5D	550	1	3 ~ 400	770	1.7	7217	14	7 × 1280	2 × 1280	11520
NEBX 5502 139 4.5D	550	2	3 ~ 400	1540	3.3	16173	18	4 × 2320	2 × 2320	13920
NEBX 5502 213 4.5D	550	2	3 ~ 400	1540	3.3	15357	17	5 × 2320	2 × 2320	16240
NEBX 5502 277 4.5D	550	2	3 ~ 400	1540	3.3	14589	17	7 × 2320	2 × 2320	20880
NEBX 5503 210 4.5D	550	3	3 ~ 400	2310	5	24284	21	4 × 3200	2 × 3200	19200
NEBX 5503 323 4.5D	550	3	3 ~ 400	2310	5	23078	21	5 × 3200	2 × 3200	22400
NEBX 5503 419 4.5D	550	3	3 ~ 400	2310	5	21945	21	7 × 3200	2 × 3200	28800
NEBX 5504 281 4.5D	550	4	3 ~ 400	3080	6.6	32425	26	4 × 4260	2 × 4260	25560
NEBX 5504 433 4.5D	550	4	3 ~ 400	3080	6.6	30792	25	5 × 4260	2 × 4260	29820
NEBX 5504 562 4.5D	550	4	3 ~ 400	3080	6.6	29328	24	7 × 4260	2 × 4260	38340

FIN SPACING 4.5 mm, with electrical defrost. Rt>=0°C

SEPARACIÓN ALETAS 4.5 mm, con desescarche eléctrico. Rt>=0°C

Modelo / Model	Capacidad / Capacity R717 (kw)		Superficie / Surface (m ²)	Volumen interno / Tube Volume (dm ³)	Filas de serpentin / Coil Rows	Peso Neto / N.W. (kg)	Conexión / Connection (ømm)	
	te= -8°C	te= -25°C					Entrada / Inlet	Salida / Outlet
	DT1=8K	DT1=7K						
NEBX 6301 91 4.5D	16.18	12.13	91.3	13.2	4	169.3	DN20	DN25
NEBX 6301 137 4.5D	19.7	15.71	137	19.8	6	201.0	DN25	DN32
NEBX 6301 187 4.5D	24.98	16.94	182.7	26.4	8	233.9	DN25	DN32
NEBX 6301 228 4.5D	27.38	18.75	228.4	33	10	269.2	DN25	DN32
NEBX 6302 187 4.5D	33.11	24.81	187	27	4	302.2	DN32	DN40
NEBX 6302 280 4.5D	43.38	32.45	280.4	40.6	6	361.9	DN32	DN40
NEBX 6302 384 4.5D	51.43	36.05	373.9	54.1	8	423.3	DN40	DN50
NEBX 6302 467 4.5D	55.91	38.35	487.4	67.6	10	488.2	DN40	DN50
NEBX 6303 283 4.5D	50.05	37.5	282.6	40.9	4	433.7	DN40	DN50
NEBX 6303 424 4.5D	66.15	44.44	423.9	61.3	6	522.3	DN40	DN50
NEBX 6303 581 4.5D	77.23	52.52	565.2	81.7	8	611.6	DN50	DN65
NEBX 6303 706 4.5D	84.49	60.4	706.4	102.2	10	706.6	DN50	DN65
NEBX 6304 378 4.5D	66.99	50.18	378.2	54.7	4	566.7	DN40	DN50
NEBX 6304 567 4.5D	87.71	65.59	567.3	82	6	682.3	2×DN40	2×DN50
NEBX 6304 778 4.5D	103.98	72.94	756.4	109.4	8	803.1	2×DN40	2×DN50
NEBX 6304 946 4.5D	111.8	74.8	945.5	136.7	10	926.6	2×DN40	2×DN50
NEBX 8001 143 4.5D	26.02	18.71	142.5	20.6	4	242.7	DN25	DN32
NEBX 8001 214 4.5D	34.13	24.61	213.8	30.9	6	297.2	DN32	DN40
NEBX 8001 292 4.5D	39.29	28.61	285	41.2	8	345.3	DN32	DN40
NEBX 8001 305 4.5D	42.52	29.6	356.3	51.5	10	397.8	DN40	DN50
NEBX 8002 291 4.5D	53.15	38.25	290.7	42	4	453.2	DN40	DN50
NEBX 8002 436 4.5D	69.61	50.21	436.1	63.1	6	535.6	DN40	DN50
NEBX 8002 597 4.5D	80.14	58.35	581.5	84.1	8	627.0	DN50	DN65
NEBX 8002 727 4.5D	86.38	59.23	726.9	105.1	10	733.7	DN50	DN65
NEBX 8003 439 4.5D	80.28	57.8	439	63.5	4	627.7	DN50	DN65
NEBX 8003 658 4.5D	105.08	75.82	658.4	95.2	6	774.8	DN50	DN65
NEBX 8003 902 4.5D	121	88.1	877.9	127	8	909.8	2×DN40	2×DN50
NEBX 8003 1097 4.5D	130.96	91.26	1097.4	158.7	10	1052.8	2×DN50	2×DN65

Modelo / Model	Ventilador con Motor Axial / Axial Fans							Desescarche Eléctrico Electric Defrost		
	Diámetro / Diameter (ø mm)	Nº	Voltaje / Voltage (V, 50Hz)	Potencia / Power (W)	Intensidad / Current (A)	Flujo de aire / Air Flow (m ³ /h)	Tiro / Air Throw (m)	Aletas / Coil (W)	Desagüe / Drain Pan (W)	Total / Total (W)
NEBX 6301 91 4.5D	630	1	3 ~ 400	1100	2.2	11835	19	4 × 1510	2 × 1510	9060
NEBX 6301 137 4.5D	630	1	3 ~ 400	1100	2.2	11179	18	6 × 1510	2 × 1510	12080
NEBX 6301 187 4.5D	630	1	3 ~ 400	1100	2.2	10548	18	7 × 1510	2 × 1510	13590
NEBX 6301 228 4.5D	630	1	3 ~ 400	1100	2.2	10054	17	10 × 1510	2 × 1510	18120
NEBX 6302 187 4.5D	630	2	3 ~ 400	2200	4.4	23771	22	4 × 2740	2 × 2740	16440
NEBX 6302 280 4.5D	630	2	3 ~ 400	2200	4.4	22471	21	6 × 2740	2 × 2740	21920
NEBX 6302 384 4.5D	630	2	3 ~ 400	2200	4.4	21267	21	7 × 2740	2 × 2740	24660
NEBX 6302 467 4.5D	630	2	3 ~ 400	2200	4.4	20276	20	10 × 2740	2 × 2740	32880
NEBX 6303 283 4.5D	630	3	3 ~ 400	3300	6.6	35705	26	4 × 3800	2 × 3800	22800
NEBX 6303 424 4.5D	630	3	3 ~ 400	3300	6.6	33745	26	6 × 3800	2 × 3800	30400
NEBX 6303 581 4.5D	630	3	3 ~ 400	3300	6.6	31977	26	7 × 3800	2 × 3800	34200
NEBX 6303 706 4.5D	630	3	3 ~ 400	3300	6.6	30503	25	10 × 3800	2 × 3800	45600
NEBX 6304 378 4.5D	630	4	3 ~ 400	4400	8.8	47639	32	4 × 5060	2 × 5060	30360
NEBX 6304 567 4.5D	630	4	3 ~ 400	4400	8.8	45072	31	6 × 5060	2 × 5060	40480
NEBX 6304 778 4.5D	630	4	3 ~ 400	4400	8.8	42697	31	7 × 5060	2 × 5060	45540
NEBX 6304 946 4.5D	630	4	3 ~ 400	4400	8.8	40713	30	10 × 5060	2 × 5060	60720
NEBX 8001 143 4.5D	800	1	3 ~ 400	1600	3.5	18983	27	5 × 1700	2 × 1700	11900
NEBX 8001 214 4.5D	800	1	3 ~ 400	1600	3.5	17756	26	8 × 1700	2 × 1700	17000
NEBX 8001 292 4.5D	800	1	3 ~ 400	1600	3.5	16554	25	10 × 1700	2 × 1700	20400
NEBX 8001 305 4.5D	800	1	3 ~ 400	1600	3.5	15486	24	14 × 1700	2 × 1700	23800
NEBX 8002 291 4.5D	800	2	3 ~ 400	3200	7	38150	31	5 × 2810	2 × 2810	19670
NEBX 8002 436 4.5D	800	2	3 ~ 400	3200	7	35709	31	8 × 2810	2 × 2810	28100
NEBX 8002 597 4.5D	800	2	3 ~ 400	3200	7	33407	30	10 × 2810	2 × 2810	33720
NEBX 8002 727 4.5D	800	2	3 ~ 400	3200	7	31288	29	14 × 2810	2 × 2810	39340
NEBX 8003 439 4.5D	800	3	3 ~ 400	4800	10.5	57314	37	5 × 4420	2 × 4420	30940
NEBX 8003 658 4.5D	800	3	3 ~ 400	4800	10.5	53658	36	8 × 4420	2 × 4420	44200
NEBX 8003 902 4.5D	800	3	3 ~ 400	4800	10.5	50257	36	10 × 4420	2 × 4420	53040
NEBX 8003 1097 4.5D	800	3	3 ~ 400	4800	10.5	47092	35	14 × 4420	2 × 4420	61880

FIN SPACING 7 mm, with electrical defrost. Rt>=-20°C

SEPARACIÓN ALETAS 7 mm, con desescarche eléctrico. Rt>=-20°C

Modelo / Model	Capacidad / Capacity R717 (kw)		Superficie / Surface (m ²)	Volumen interno / Tube Volume (dm ³)	Filas de serpentin / Coil Rows	Peso Neto / N.W. (kg)	Conexión / Connection (ømm)	
	te= -8°C	te= -25°C					Entrada / Inlet	Salida / Outlet
	DT1=8K	DT1=7K						
NEBX 5001 35 7D	6.8	5.46	33.2	6.9		99.6	DN15	DN20
NEBX 5001 52 7D	10.14	7.39	49.9	10.3		118.1	DN15	DN20
NEBX 5002 69 7D	15.01	11.28	68.4	14.2		172.2	DN25	DN32
NEBX 5002 103 7D	20.83	15.17	102.5	21.3		206.8	DN25	DN32
NEBX 5003 103 7D	23.01	16.79	103.5	21.5		245.2	DN25	DN32
NEBX 5003 156 7D	31.52	22.95	155.2	32.2		294.5	DN32	DN40
NEBX 5004 139 7D	30.44	22.88	138.6	28.7		317.8	DN32	DN40
NEBX 5004 209 7D	41.64	31.14	207.9	43.1		383.4	DN40	DN50
NEBX 5501 44 7D	9.12	6.85	44.4	9.2	4	127.1	DN15	DN20
NEBX 5501 67 7D	12.41	9.29	66.5	13.8	6	146.0	DN20	DN25
NEBX 5501 89 7D	14.92	11.15	88.7	18.4	8	172.3	DN20	DN25
NEBX 5502 91 7D	18.73	14.05	91.2	18.9	4	221.1	DN25	DN32
NEBX 5502 137 7D	25.45	19.04	136.8	28.4	6	256.7	DN25	DN32
NEBX 5502 182 7D	30.58	22.81	182.5	37.8	8	304.1	DN32	DN40
NEBX 5503 138 7D	28.48	19.19	138.1	28.6	4	313.6	DN32	DN40
NEBX 5503 208 7D	39.08	28.5	207.1	42.9	6	367.5	DN32	DN40
NEBX 5503 276 7D	47.17	32.16	276.2	57.3	8	434.6	DN40	DN50
NEBX 5504 185 7D	37.94	28.46	185	38.4	4	407.5	DN32	DN40
NEBX 5504 278 7D	52.25	35.42	277.4	57.5	6	477.3	DN40	DN50
NEBX 5504 370 7D	61.9	46.14	369.9	76.7	8	566.5	2×DN32	2×DN40

Modelo / Model	Ventilador con Motor Axial / Axial Fans							Desescarche Eléctrico Electric Defrost		
	Diámetro / Diameter (ø mm)	Nº	Voltaje / Voltage (V, 50Hz)	Potencia / Power (W)	Intensidad / Current (A)	Flujo de aire / Air Flow (m3/h)	Tiro / Air Throw (m)	Aletas / Coil (W)	Desagüe / Drain Pan (W)	Total / Total (W)
NEBX 5001 35 7D	500	1	3 ~ 400	650	1.2	7133	16	3 × 1280	2 × 1280	6400
NEBX 5001 52 7D	500	1	3 ~ 400	650	1.2	6778	16	4 × 1280	2 × 1280	7680
NEBX 5002 69 7D	500	2	3 ~ 400	1300	2.3	14332	20	3 × 2320	2 × 2320	11600
NEBX 5002 103 7D	500	2	3 ~ 400	1300	2.3	13659	19	4 × 2320	2 × 2320	13920
NEBX 5003 103 7D	500	3	3 ~ 400	1950	3.5	21534	24	3 × 3200	2 × 3200	16000
NEBX 5003 156 7D	500	3	3 ~ 400	1950	3.5	20537	23	4 × 3200	2 × 3200	19200
NEBX 5004 139 7D	500	4	3 ~ 400	2600	4.6	28753	28	3 × 4260	2 × 4260	21300
NEBX 5004 209 7D	500	4	3 ~ 400	2600	4.6	27424	28	4 × 4260	2 × 4260	25560
NEBX 5501 44 7D	550	1	3 ~ 400	770	1.7	8263	15	4 × 1280	2 × 1280	7680
NEBX 5501 67 7D	550	1	3 ~ 400	770	1.7	7891	15	5 × 1280	2 × 1280	8960
NEBX 5501 89 7D	550	1	3 ~ 400	770	1.7	7580	14	7 × 1280	2 × 1280	11520
NEBX 5502 91 7D	550	2	3 ~ 400	1540	3.3	16597	19	4 × 2320	2 × 2320	13920
NEBX 5502 137 7D	550	2	3 ~ 400	1540	3.3	15867	18	5 × 2320	2 × 2320	16240
NEBX 5502 182 7D	550	2	3 ~ 400	1540	3.3	15264	18	7 × 2320	2 × 2320	20880
NEBX 5503 138 7D	550	3	3 ~ 400	2310	5	24912	22	4 × 3200	2 × 3200	19200
NEBX 5503 208 7D	550	3	3 ~ 400	2310	5	23837	22	5 × 3200	2 × 3200	22400
NEBX 5503 276 7D	550	3	3 ~ 400	2310	5	22931	21	7 × 3200	2 × 3200	28800
NEBX 5504 185 7D	550	4	3 ~ 400	3080	6.6	33260	26	4 × 4260	2 × 4260	25560
NEBX 5504 278 7D	550	4	3 ~ 400	3080	6.6	31797	26	5 × 4260	2 × 4260	29820
NEBX 5504 370 7D	560	4	3 ~ 400	3080	6.6	30647	26	7 × 4260	2 × 4260	38340

FIN SPACING 7 mm, with electrical defrost. Rt>=-20°C

SEPARACIÓN ALETAS 7 mm, con desescarche eléctrico. Rt>=-20°C

Modelo / Model	Capacidad / Capacity R717 (kw)		Superficie / Surface (m ²)	Volumen interno / Tube Volume (dm ³)	Filas de serpentin / Coil Rows	Peso Neto / N.W. (kg)	Conexión / Connection (ømm)	
	te= -8°C	te= -25°C					Entrada / Inlet	Salida / Outlet
	DT1=8K	DT1=7K						
NEBX 6301 60 7D	12.61	9.7	60.1	13.2	4	162.2	DN20	DN25
NEBX 6301 90 7D	15.79	12.81	90.2	19.8	6	190.4	DN25	DN32
NEBX 6301 120 7D	21.68	15.15	120.3	26.4	8	219.6	DN25	DN32
NEBX 6301 150 7D	24.46	17.19	150.4	33	10	251.4	DN25	DN32
NEBX 6302 123 7D	25.79	19.8	123.1	27	4	288.1	DN32	DN40
NEBX 6302 185 7D	35.26	26.98	184.7	40.6	6	340.7	DN32	DN40
NEBX 6302 247 7D	44.21	31.81	246.2	54.1	8	395.1	DN40	DN50
NEBX 6302 308 7D	49.95	35.14	307.8	67.6	10	453.0	DN40	DN50
NEBX 6303 186 7D	38.97	29.9	186.1	40.9	4	412.5	DN40	DN50
NEBX 6303 279 7D	55.4	38.6	279.1	61.3	6	490.5	DN40	DN50
NEBX 6303 373 7D	66.95	46.85	372.1	81.7	8	569.2	DN50	DN65
NEBX 6303 465 7D	74.69	54.59	465.2	102.2	10	653.6	DN50	DN65
NEBX 6304 249 7D	52.15	40.01	249	54.7	4	538.4	DN40	DN50
NEBX 6304 374 7D	71.28	54.51	373.5	82	6	639.9	2×DN40	2×DN50
NEBX 6304 500 7D	89.36	64.3	498	109.4	8	746.5	2×DN40	2×DN50
NEBX 6304 623 7D	100.61	69.08	622.6	136.7	10	855.9	2×DN40	2×DN50
NEBX 8001 94 7D	20.61	15.32	93.8	20.6	4	231.9	DN25	DN32
NEBX 8001 141 7D	28.03	20.83	140.8	30.9	6	280.9	DN32	DN40
NEBX 8001 188 7D	33.74	25.04	187.7	41.2	8	323.5	DN32	DN40
NEBX 8001 201 7D	38.39	27.32	234.6	51.5	10	370.6	DN40	DN50
NEBX 8002 191 7D	42.05	31.25	191.4	42	4	431.3	DN40	DN50
NEBX 8002 287 7D	57.17	42.46	287.2	63.1	6	502.8	DN40	DN50
NEBX 8002 384 7D	68.76	50.97	382.9	84.1	8	583.3	DN50	DN65
NEBX 8002 479 7D	78.27	54.91	478.6	105.1	10	678.9	DN50	DN65
NEBX 8003 289 7D	63.48	47.18	289	63.5	4	594.8	DN50	DN65
NEBX 8003 434 7D	86.3	64.1	433.5	95.2	6	725.5	DN50	DN65
NEBX 8003 580 7D	103.77	76.9	578.1	127	8	844.0	2×DN40	2×DN50
NEBX 8003 723 7D	118.17	84.16	722.6	158.7	10	970.6	2×DN50	2×DN65

Modelo / Model	Ventilador con Motor Axial / Axial Fans							Desescarche Eléctrico Electric Defrost		
	Diámetro / Diameter (ø mm)	Nº	Voltaje / Voltage (V, 50Hz)	Potencia / Power (W)	Intensidad / Current (A)	Flujo de aire / Air Flow (m3/h)	Tiro / Air Throw (m)	Aletas / Coil (W)	Desagüe / Drain Pan (W)	Total / Total (W)
NEBX 6301 60 7D	630	1	3 ~ 400	1100	2.2	12122	21	4 × 1510	2 × 1510	9060
NEBX 6301 90 7D	630	1	3 ~ 400	1100	2.2	11609	20	6 × 1510	2 × 1510	12080
NEBX 6301 120 7D	630	1	3 ~ 400	1100	2.2	11070	19	7 × 1510	2 × 1510	13590
NEBX 6301 150 7D	630	1	3 ~ 400	1100	2.2	10597	18	10 × 1510	2 × 1510	18120
NEBX 6302 123 7D	630	2	3 ~ 400	2200	4.4	24310	23	4 × 2740	2 × 2740	16440
NEBX 6302 185 7D	630	2	3 ~ 400	2200	4.4	23305	23	6 × 2740	2 × 2740	21920
NEBX 6302 247 7D	630	2	3 ~ 400	2200	4.4	22296	22	7 × 2740	2 × 2740	24660
NEBX 6302 308 7D	630	2	3 ~ 400	2200	4.4	21361	21	10 × 2740	2 × 2740	32880
NEBX 6303 186 7D	630	3	3 ~ 400	3300	6.6	36491	28	4 × 3800	2 × 3800	22800
NEBX 6303 279 7D	630	3	3 ~ 400	3300	6.6	34982	27	6 × 3800	2 × 3800	30400
NEBX 6303 373 7D	630	3	3 ~ 400	3300	6.6	33509	27	7 × 3800	2 × 3800	34200
NEBX 6303 465 7D	630	3	3 ~ 400	3300	6.6	32132	26	10 × 3800	2 × 3800	45600
NEBX 6304 249 7D	630	4	3 ~ 400	4400	8.8	48671	33	4 × 5060	2 × 5060	30360
NEBX 6304 374 7D	630	4	3 ~ 400	4400	8.8	46724	33	6 × 5060	2 × 5060	40480
NEBX 6304 500 7D	630	4	3 ~ 400	4400	8.8	44736	32	7 × 5060	2 × 5060	45540
NEBX 6304 623 7D	630	4	3 ~ 400	4400	8.8	42877	31	10 × 5060	2 × 5060	60720
NEBX 8001 94 7D	800	1	3 ~ 400	1600	3.5	19646	27	5 × 1700	2 × 1700	11900
NEBX 8001 141 7D	800	1	3 ~ 400	1600	3.5	18494	27	8 × 1700	2 × 1700	17000
NEBX 8001 188 7D	800	1	3 ~ 400	1600	3.5	17614	26	10 × 1700	2 × 1700	20400
NEBX 8001 201 7D	800	1	3 ~ 400	1600	3.5	16649	25	14 × 1700	2 × 1700	23800
NEBX 8002 191 7D	800	2	3 ~ 400	3200	7	39432	32	5 × 2810	2 × 2810	19670
NEBX 8002 287 7D	800	2	3 ~ 400	3200	7	37182	31	8 × 2810	2 × 2810	28100
NEBX 8002 384 7D	800	2	3 ~ 400	3200	7	35449	31	10 × 2810	2 × 2810	33720
NEBX 8002 479 7D	800	2	3 ~ 400	3200	7	33592	30	14 × 2810	2 × 2810	39340
NEBX 8003 289 7D	800	3	3 ~ 400	4800	10.5	59217	38	5 × 4420	2 × 4420	30940
NEBX 8003 434 7D	800	3	3 ~ 400	4800	10.5	55869	37	8 × 4420	2 × 4420	44200
NEBX 8003 580 7D	800	3	3 ~ 400	4800	10.5	53273	37	10 × 4420	2 × 4420	53040
NEBX 8003 723 7D	800	3	3 ~ 400	4800	10.5	50540	36	14 × 4420	2 × 4420	61880

FIN SPACING 10 mm, with electrical defrost. Rt>=-40°C

SEPARACIÓN ALETAS 10 mm, con desescarche eléctrico. Rt>=-40°C

Modelo / Model	Capacidad / Capacity R717 (kw)		Superficie / Surface (m ²)	Volumen interno / Tube Volume (dm ³)	Filas de serpentin / Coil Rows	Peso Neto / N.W. (kg)	Conexión / Connection (ømm)	
	te= -8°C	te= -25°C					Entrada / Inlet	Salida / Outlet
	DT1=8K	DT1=7K						
NEBX 5001 25 10D	5.56	4.49	23.9	6.9		97.5	DN15	DN20
NEBX 5001 37 10D	8.58	6.35	35.9	10.3		115.0	DN15	DN20
NEBX 5002 49 10D	12.38	9.42	49.2	14.2		168.2	DN25	DN32
NEBX 5002 75 10D	17.6	13.01	73.8	21.3		200.7	DN25	DN32
NEBX 5003 75 10D	19.08	14.15	74.5	21.5		239.1	DN25	DN32
NEBX 5003 111 10D	26.63	19.68	111.7	32.2		285.5	DN32	DN40
NEBX 5004 98 10D	25.1	19.09	99.8	28.7		309.8	DN32	DN40
NEBX 5004 147 10D	35.03	26.46	149.6	43.1		371.4	DN40	DN50
NEBX 5501 32 10D	7.49	5.69	31.9	9.2	4	124.4	DN15	DN20
NEBX 5501 47 10D	10.45	7.92	47.9	13.8	6	142.1	DN20	DN25
NEBX 5501 64 10D	12.86	9.72	63.9	18.4	8	167.0	DN20	DN25
NEBX 5502 66 10D	15.38	11.67	65.7	18.9	4	215.8	DN25	DN32
NEBX 5502 96 10D	21.43	16.2	98.5	28.4	6	248.8	DN25	DN32
NEBX 5502 131 10D	26.34	19.86	131.3	37.8	8	293.5	DN32	DN40
NEBX 5503 99 10D	23.97	16.58	99.4	28.6	4	305.7	DN32	DN40
NEBX 5503 145 10D	33.04	24.43	149.1	42.9	6	355.7	DN32	DN40
NEBX 5503 199 10D	41.35	28.76	198.8	57.3	8	418.7	DN40	DN50
NEBX 5504 133 10D	31.15	23.61	133.1	38.4	4	396.9	DN32	DN40
NEBX 5504 195 10D	44.89	31.14	199.7	57.5	6	461.4	DN40	DN50
NEBX 5504 266 10D	53.31	40.15	266.3	76.7	8	545.4	2×DN32	2×DN40

Modelo / Model	Ventilador con Motor Axial / Axial Fans							Desescarche Eléctrico Electric Defrost		
	Diámetro / Diameter (ø mm)	Nº	Voltaje / Voltage (V, 50Hz)	Potencia / Power (W)	Intensidad / Current (A)	Flujo de aire / Air Flow (m3/h)	Tiro / Air Throw (m)	Aletas / Coil (W)	Desagüe / Drain Pan (W)	Total / Total (W)
NEBX 5001 25 10D	500	1	3 ~ 400	650	1.2	7311	17	3 × 1280	2 × 1280	6400
NEBX 5001 37 10D	500	1	3 ~ 400	650	1.2	6959	16	4 × 1280	2 × 1280	7680
NEBX 5002 49 10D	500	2	3 ~ 400	1300	2.3	14683	20	3 × 2320	2 × 2320	11600
NEBX 5002 75 10D	500	2	3 ~ 400	1300	2.3	13978	20	4 × 2320	2 × 2320	13920
NEBX 5003 75 10D	500	3	3 ~ 400	1950	3.5	22055	24	3 × 3200	2 × 3200	16000
NEBX 5003 111 10D	500	3	3 ~ 400	1950	3.5	20999	24	4 × 3200	2 × 3200	19200
NEBX 5004 98 10D	500	4	3 ~ 400	2600	4.6	29444	29	3 × 4260	2 × 4260	21300
NEBX 5004 147 10D	500	4	3 ~ 400	2600	4.6	28064	28	4 × 4260	2 × 4260	25560
NEBX 5501 32 10D	550	1	3 ~ 400	770	1.7	8405	16	4 × 1280	2 × 1280	7680
NEBX 5501 47 10D	550	1	3 ~ 400	770	1.7	8071	16	5 × 1280	2 × 1280	8960
NEBX 5501 64 10D	550	1	3 ~ 400	770	1.7	7787	15	7 × 1280	2 × 1280	11520
NEBX 5502 66 10D	550	2	3 ~ 400	1540	3.3	16872	19	4 × 2320	2 × 2320	13920
NEBX 5502 96 10D	550	2	3 ~ 400	1540	3.3	16222	19	5 × 2320	2 × 2320	16240
NEBX 5502 131 10D	550	2	3 ~ 400	1540	3.3	15667	18	7 × 2320	2 × 2320	20880
NEBX 5503 99 10D	550	3	3 ~ 400	2310	5	25320	23	4 × 3200	2 × 3200	19200
NEBX 5503 145 10D	550	3	3 ~ 400	2310	5	24366	22	5 × 3200	2 × 3200	22400
NEBX 5503 199 10D	550	3	3 ~ 400	2310	5	23529	22	7 × 3200	2 × 3200	28800
NEBX 5504 133 10D	550	4	3 ~ 400	3080	6.6	33801	28	4 × 4260	2 × 4260	25560
NEBX 5504 195 10D	550	4	3 ~ 400	3080	6.6	32499	27	5 × 4260	2 × 4260	29820
NEBX 5504 266 10D	550	4	3 ~ 400	3080	6.6	31422	27	7 × 4260	2 × 4260	38340

FIN SPACING 10 mm, with electrical defrost. Rt>=-40°C

SEPARACIÓN ALETAS 10 mm, con desescarche eléctrico. Rt>=-40°C

Modelo / Model	Capacidad / Capacity R717 (kw)		Superficie / Surface (m ²)	Volumen interno / Tube Volume (dm ³)	Filas de serpentin / Coil Rows	Peso Neto / N.W. (kg)	Conexión / Connection (ømm)	
	te= -8°C	te= -25°C					Entrada / Inlet	Salida / Outlet
	DT1=8K	DT1=7K						
NEBX 6301 43 10D	10.29	7.99	43.3	13.2	4	158.7	DN20	DN25
NEBX 6301 65 10D	13.14	10.7	64.9	19.8	6	185.2	DN25	DN32
NEBX 6301 84 10D	18.93	13.47	86.6	26.4	8	212.7	DN25	DN32
NEBX 6301 108 10D	21.81	15.57	108.2	33	10	242.7	DN25	DN32
NEBX 6302 89 10D	21.04	16.29	88.6	27	4	281.0	DN32	DN40
NEBX 6302 133 10D	29.56	22.8	132.9	40.6	6	330.1	DN32	DN40
NEBX 6302 173 10D	38.35	27.99	177.2	54.1	8	381.0	DN40	DN50
NEBX 6302 222 10D	44.52	31.79	221.6	67.6	10	435.3	DN40	DN50
NEBX 6303 134 10D	31.78	24.59	133.9	40.9	4	401.8	DN40	DN50
NEBX 6303 201 10D	47.27	33.6	200.9	61.3	6	474.5	DN40	DN50
NEBX 6303 261 10D	58.37	41.58	267.9	81.7	8	547.8	DN50	DN65
NEBX 6303 335 10D	66.09	48.84	334.9	102.2	10	626.9	DN50	DN65
NEBX 6304 179 10D	42.53	32.9	179.3	54.7	4	524.3	DN40	DN50
NEBX 6304 269 10D	59.74	46.03	268.9	82	6	618.6	2×DN40	2×DN50
NEBX 6304 350 10D	77.46	56.55	358.5	109.4	8	718.2	2×DN40	2×DN50
NEBX 6304 448 10D	90.1	62.9	448.2	136.7	10	820.5	2×DN40	2×DN50
NEBX 8001 68 10D	17	12.82	67.6	20.6	4	226.4	DN25	DN32
NEBX 8001 101 10D	23.71	17.85	101.3	30.9	6	272.6	DN32	DN40
NEBX 8001 132 10D	29.14	21.89	135.1	41.2	8	312.6	DN32	DN40
NEBX 8001 144 10D	34.41	24.74	168.9	51.5	10	356.9	DN40	DN50
NEBX 8002 138 10D	34.66	26.11	137.8	42	4	420.4	DN40	DN50
NEBX 8002 207 10D	48.33	36.35	206.7	63.1	6	486.3	DN40	DN50
NEBX 8002 269 10D	59.34	44.55	275.6	84.1	8	561.3	DN50	DN65
NEBX 8002 345 10D	70.25	49.82	344.5	105.1	10	651.5	DN50	DN65
NEBX 8003 208 10D	52.32	39.4	208.1	63.5	4	578.3	DN50	DN65
NEBX 8003 312 10D	72.95	54.86	312.1	95.2	6	700.8	DN50	DN65
NEBX 8003 406 10D	89.55	67.21	416.1	127	8	811.1	2×DN40	2×DN50
NEBX 8003 520 10D	105.71	75.99	520.2	158.7	10	929.4	2×DN50	2×DN65

Modelo / Model	Ventilador con Motor Axial / Axial Fans							Desescarche Eléctrico Electric Defrost		
	Diámetro / Diameter (ø mm)	Nº	Voltaje / Voltage (V, 50Hz)	Potencia / Power (W)	Intensidad / Current (A)	Flujo de aire / Air Flow (m ³ /h)	Tiro / Air Throw (m)	Aletas / Coil (W)	Desagüe / Drain Pan (W)	Total / Total (W)
NEBX 6301 43 10D	630	1	3 ~ 400	1100	2.2	12256	20	4 × 1510	2 × 1510	9060
NEBX 6301 65 10D	630	1	3 ~ 400	1100	2.2	11887	20	6 × 1510	2 × 1510	12080
NEBX 6301 84 10D	630	1	3 ~ 400	1100	2.2	11414	19	7 × 1510	2 × 1510	13590
NEBX 6301 108 10D	630	1	3 ~ 400	1100	2.2	10996	18	10 × 1510	2 × 1510	18120
NEBX 6302 89 10D	630	2	3 ~ 400	2200	4.4	24561	24	4 × 2740	2 × 2740	16440
NEBX 6302 133 10D	630	2	3 ~ 400	2200	4.4	23845	23	6 × 2740	2 × 2740	21920
NEBX 6302 173 10D	630	2	3 ~ 400	2200	4.4	22958	23	7 × 2740	2 × 2740	24660
NEBX 6302 222 10D	630	2	3 ~ 400	2200	4.4	22146	22	10 × 2740	2 × 2740	32880
NEBX 6303 134 10D	630	3	3 ~ 400	3300	6.6	36865	29	4 × 3800	2 × 3800	22800
NEBX 6303 201 10D	630	3	3 ~ 400	3300	6.6	35783	29	6 × 3800	2 × 3800	30400
NEBX 6303 261 10D	630	3	3 ~ 400	3300	6.6	34491	28	7 × 3800	2 × 3800	34200
NEBX 6303 335 10D	630	3	3 ~ 400	3300	6.6	33305	27	10 × 3800	2 × 3800	45600
NEBX 6304 179 10D	630	4	3 ~ 400	4400	8.8	49169	34	4 × 5060	2 × 5060	30360
NEBX 6304 269 10D	630	4	3 ~ 400	4400	8.8	47786	33	6 × 5060	2 × 5060	40480
NEBX 6304 350 10D	630	4	3 ~ 400	4400	8.8	46037	33	7 × 5060	2 × 5060	45540
NEBX 6304 448 10D	630	4	3 ~ 400	4400	8.8	44433	32	10 × 5060	2 × 5060	60720
NEBX 8001 68 10D	800	1	3 ~ 400	1600	3.5	20044	28	5 × 1700	2 × 1700	11900
NEBX 8001 101 10D	800	1	3 ~ 400	1600	3.5	19061	28	8 × 1700	2 × 1700	17000
NEBX 8001 132 10D	800	1	3 ~ 400	1600	3.5	18192	27	10 × 1700	2 × 1700	20400
NEBX 8001 144 10D	800	1	3 ~ 400	1600	3.5	17480	26	14 × 1700	2 × 1700	23800
NEBX 8002 138 10D	800	2	3 ~ 400	3200	7	40211	33	5 × 2810	2 × 2810	19670
NEBX 8002 207 10D	800	2	3 ~ 400	3200	7	38304	32	8 × 2810	2 × 2810	28100
NEBX 8002 269 10D	800	2	3 ~ 400	3200	7	36566	32	10 × 2810	2 × 2810	33720
NEBX 8002 345 10D	800	2	3 ~ 400	3200	7	35174	31	14 × 2810	2 × 2810	39340
NEBX 8003 208 10D	800	3	3 ~ 400	4800	10.5	60376	39	5 × 4420	2 × 4420	30940
NEBX 8003 312 10D	800	3	3 ~ 400	4800	10.5	57544	38	8 × 4420	2 × 4420	44200
NEBX 8003 406 10D	800	3	3 ~ 400	4800	10.5	54938	38	10 × 4420	2 × 4420	53040
NEBX 8003 520 10D	800	3	3 ~ 400	4800	10.5	52879	37	14 × 4420	2 × 4420	61880

FIN SPACING 12 mm, with electrical defrost. Rt>=-40°C

SEPARACIÓN ALETAS 12 mm, con desescarche eléctrico. Rt>=-40°C

Modelo / Model	Capacidad / Capacity R717 (kw)		Superficie / Surface (m ²)	Volumen interno / Tube Volume (dm ³)	Filas de serpentin / Coil Rows	Peso Neto / N.W. (kg)	Conexión / Connection (ømm)	
	te= -25°C	te= -31°C					Entrada / Inlet	Salida / Outlet
	DTI=7K	DTI=6K						
NEBX 5001 20 12D	3.97	3.32	20.3	7.3		96.8	DN15	DN20
NEBX 5001 31 12D	5.74	4.75	30.5	11		114.0	DN15	DN20
NEBX 5002 42 12D	8.4	6.98	41.8	15		166.8	DN25	DN32
NEBX 5002 63 12D	11.77	9.76	62.6	22.5		198.7	DN25	DN32
NEBX 5003 63 12D	12.67	10.47	63.2	22.7		237.1	DN25	DN32
NEBX 5003 95 12D	17.8	14.78	94.8	34.1		282.5	DN32	DN40
NEBX 5004 85 12D	17.02	14.15	84.7	30.4		307.2	DN32	DN40
NEBX 5004 127 12D	23.84	19.93	127	45.7		367.4	DN40	DN50
NEBX 5501 27 12D	5.07	4.22	27.1	9.7	4	123.4	DN15	DN20
NEBX 5501 41 12D	7.13	5.96	40.7	14.6	6	140.5	DN20	DN25
NEBX 5501 54 12D	8.85	7.42	54.2	19.5	8	164.9	DN20	DN25
NEBX 5502 56 12D	10.37	8.65	55.7	20	4	213.9	DN25	DN32
NEBX 5502 84 12D	14.59	12.21	83.6	30.1	6	246.0	DN25	DN32
NEBX 5502 112 12D	18.09	15.21	111.5	40.1	8	289.7	DN32	DN40
NEBX 5503 84 12D	15.17	12.73	84.4	30.3	4	302.9	DN32	DN40
NEBX 5503 127 12D	22.08	18.39	126.5	45.5	6	351.5	DN32	DN40
NEBX 5503 169 12D	26.39	22.29	168.7	60.7	8	413.1	DN40	DN50
NEBX 5504 113 12D	20.99	17.52	113	40.6	4	393.3	DN32	DN40
NEBX 5504 170 12D	29.51	24.73	169.5	60.9	6	455.9	DN40	DN50
NEBX 5504 226 12D	36.58	30.77	226	81.2	8	538.1	2×DN32	2×DN40

Modelo / Model	Ventilador con Motor Axial / Axial Fans							Desescarche Eléctrico Electric Defrost		
	Diámetro / Diameter (ø mm)	Nº	Voltaje / Voltage (V, 50Hz)	Potencia / Power (W)	Intensidad / Current (A)	Flujo de aire / Air Flow (m ³ /h)	Tiro / Air Throw (m)	Aletas / Coil (W)	Desagüe / Drain Pan (W)	Total / Total (W)
NEBX 5001 20 12D	500	1	3 ~ 400	650	1.2	7404	17	3 × 1280	2 × 1280	6400
NEBX 5001 31 12D	500	1	3 ~ 400	650	1.2	7037	16	4 × 1280	2 × 1280	7680
NEBX 5002 42 12D	500	2	3 ~ 400	1300	2.3	14862	20	3 × 2320	2 × 2320	11600
NEBX 5002 63 12D	500	2	3 ~ 400	1300	2.3	14119	20	4 × 2320	2 × 2320	13920
NEBX 5003 63 12D	500	3	3 ~ 400	1950	3.5	22321	24	3 × 3200	2 × 3200	16000
NEBX 5003 95 12D	500	3	3 ~ 400	1950	3.5	21208	24	4 × 3200	2 × 3200	19200
NEBX 5004 85 12D	500	4	3 ~ 400	2600	4.6	29799	29	3 × 4260	2 × 4260	21300
NEBX 5004 127 12D	500	4	3 ~ 400	2600	4.6	28305	28	4 × 4260	2 × 4260	25560
NEBX 5501 27 12D	550	1	3 ~ 400	770	1.7	8473	15	4 × 1280	2 × 1280	7680
NEBX 5501 41 12D	550	1	3 ~ 400	770	1.7	8161	16	5 × 1280	2 × 1280	8960
NEBX 5501 54 12D	550	1	3 ~ 400	770	1.7	7889	14	7 × 1280	2 × 1280	11520
NEBX 5502 56 12D	550	2	3 ~ 400	1540	3.3	17001	18	4 × 2320	2 × 2320	13920
NEBX 5502 84 12D	550	2	3 ~ 400	1540	3.3	16397	19	5 × 2320	2 × 2320	16240
NEBX 5502 112 12D	550	2	3 ~ 400	1540	3.3	15864	17	7 × 2320	2 × 2320	20880
NEBX 5503 84 12D	550	3	3 ~ 400	2310	5	25511	22	4 × 3200	2 × 3200	19200
NEBX 5503 127 12D	550	3	3 ~ 400	2310	5	24625	22	5 × 3200	2 × 3200	22400
NEBX 5503 169 12D	550	3	3 ~ 400	2310	5	23819	21	7 × 3200	2 × 3200	28800
NEBX 5504 113 12D	550	4	3 ~ 400	3080	6.6	34056	26	4 × 4260	2 × 4260	25560
NEBX 5504 170 12D	550	4	3 ~ 400	3080	6.6	32842	27	5 × 4260	2 × 4260	29820
NEBX 5504 226 12D	550	4	3 ~ 400	3080	6.6	31811	25	7 × 4260	2 × 4260	38340

FIN SPACING 12 mm, with electrical defrost. Rt>=-40°C

SEPARACIÓN ALETAS 12 mm, con desescarche eléctrico. Rt>=-40°C

Modelo / Model	Capacidad / Capacity R717 (kw)		Superficie / Surface (m ²)	Volumen interno / Tube Volume (dm ³)	Filas de serpentin / Coil Rows	Peso Neto / N.W. (kg)	Conexión / Connection (ømm)	
	te= -25°C	te= -31°C					Entrada / Inlet	Salida / Outlet
	DTI=7K	DTI=6K						
NEBX 6301 37 12D	7.07	5.9	36.7	13.2	4	157.4	DN20	DN25
NEBX 6301 55 12D	9.54	8.01	55.1	19.8	6	183.2	DN25	DN32
NEBX 6301 74 12D	12.4	10.19	73.5	26.4	8	210.1	DN25	DN32
NEBX 6301 92 12D	14.47	11.96	91.9	33	10	239.5	DN25	DN32
NEBX 6302 75 12D	14.42	12.05	75.2	27	4	278.5	DN32	DN40
NEBX 6302 113 12D	20.44	17.14	112.8	40.6	6	326.5	DN32	DN40
NEBX 6302 150 12D	25.64	21.3	150.4	54.1	8	376.2	DN40	DN50
NEBX 6302 188 12D	29.54	24.46	188	67.6	10	429.2	DN40	DN50
NEBX 6303 114 12D	21.77	18.21	113.7	40.9	4	398.1	DN40	DN50
NEBX 6303 171 12D	30.57	25.04	170.5	61.3	6	468.9	DN40	DN50
NEBX 6303 227 12D	38.25	31.52	227.3	81.7	8	540.6	DN50	DN65
NEBX 6303 284 12D	45.1	37.83	284.2	102.2	10	617.6	DN50	DN65
NEBX 6304 152 12D	29.12	24.36	152.1	54.7	4	519.4	DN40	DN50
NEBX 6304 228 12D	41.27	34.62	228.2	82	6	611.6	2×DN40	2×DN50
NEBX 6304 304 12D	51.78	43.07	304.3	109.4	8	708.5	2×DN40	2×DN50
NEBX 6304 380 12D	58.68	48.18	380.3	136.7	10	808.3	2×DN40	2×DN50
NEBX 8001 57 12D	11.43	9.47	57.3	20.6	4	224.5	DN25	DN32
NEBX 8001 86 12D	16.12	13.41	86	30.9	6	269.7	DN32	DN40
NEBX 8001 115 12D	20	16.72	114.7	41.2	8	308.7	DN32	DN40
NEBX 8001 123 12D	22.98	19.03	143.3	51.5	10	352.1	DN40	DN50
NEBX 8002 117 12D	23.27	19.32	117	42	4	416.5	DN40	DN50
NEBX 8002 175 12D	32.8	27.34	175.4	63.1	6	480.6	DN40	DN50
NEBX 8002 234 12D	40.68	34.07	233.9	84.1	8	553.6	DN50	DN65
NEBX 8002 292 12D	46.37	38.28	292.4	105.1	10	641.9	DN50	DN65
NEBX 8003 177 12D	35.11	29.16	176.6	63.5	4	572.6	DN50	DN65
NEBX 8003 265 12D	49.48	41.26	264.9	95.2	6	692.1	DN50	DN65
NEBX 8003 353 12D	61.36	51.42	353.2	127	8	799.6	2×DN40	2×DN50
NEBX 8003 442 12D	70.55	58.59	441.5	158.7	10	915.0	2×DN50	2×DN65

Modelo / Model	Ventilador con Motor Axial / Axial Fans							Desescarche Eléctrico Electric Defrost		
	Diámetro / Diameter (ø mm)	Nº	Voltaje / Voltage (V, 50Hz)	Potencia / Power (W)	Intensidad / Current (A)	Flujo de aire / Air Flow (m ³ /h)	Tiro / Air Throw (m)	Aletas / Coil (W)	Desagüe / Drain Pan (W)	Total / Total (W)
NEBX 6301 37 12D	630	1	3 ~ 400	1100	2.2	12322	20	4 × 1510	2 × 1510	9060
NEBX 6301 55 12D	630	1	3 ~ 400	1100	2.2	12018	20	6 × 1510	2 × 1510	12080
NEBX 6301 74 12D	630	1	3 ~ 400	1100	2.2	11578	19	7 × 1510	2 × 1510	13590
NEBX 6301 92 12D	630	1	3 ~ 400	1100	2.2	11194	18	10 × 1510	2 × 1510	18120
NEBX 6302 75 12D	630	2	3 ~ 400	2200	4.4	24689	23	4 × 2740	2 × 2740	16440
NEBX 6302 113 12D	630	2	3 ~ 400	2200	4.4	24083	23	6 × 2740	2 × 2740	21920
NEBX 6302 150 12D	630	2	3 ~ 400	2200	4.4	23280	23	7 × 2740	2 × 2740	24660
NEBX 6302 188 12D	630	2	3 ~ 400	2200	4.4	22525	22	10 × 2740	2 × 2740	32880
NEBX 6303 114 12D	630	3	3 ~ 400	3300	6.6	37056	28	4 × 3800	2 × 3800	22800
NEBX 6303 171 12D	630	3	3 ~ 400	3300	6.6	36132	28	6 × 3800	2 × 3800	30400
NEBX 6303 227 12D	630	3	3 ~ 400	3300	6.6	34970	28	7 × 3800	2 × 3800	34200
NEBX 6303 284 12D	630	3	3 ~ 400	3300	6.6	33864	27	10 × 3800	2 × 3800	45600
NEBX 6304 152 12D	630	4	3 ~ 400	4400	8.8	49422	34	4 × 5060	2 × 5060	30360
NEBX 6304 228 12D	630	4	3 ~ 400	4400	8.8	48226	34	6 × 5060	2 × 5060	40480
NEBX 6304 304 12D	630	4	3 ~ 400	4400	8.8	46675	33	7 × 5060	2 × 5060	45540
NEBX 6304 380 12D	630	4	3 ~ 400	4400	8.8	45172	32	10 × 5060	2 × 5060	60720
NEBX 8001 57 12D	800	1	3 ~ 400	1600	3.5	20234	30	5 × 1700	2 × 1700	11900
NEBX 8001 86 12D	800	1	3 ~ 400	1600	3.5	19341	29	8 × 1700	2 × 1700	17000
NEBX 8001 115 12D	800	1	3 ~ 400	1600	3.5	18487	27	10 × 1700	2 × 1700	20400
NEBX 8001 123 12D	800	1	3 ~ 400	1600	3.5	17811	26	14 × 1700	2 × 1700	23800
NEBX 8002 117 12D	800	2	3 ~ 400	3200	7	40581	36	5 × 2810	2 × 2810	19670
NEBX 8002 175 12D	800	2	3 ~ 400	3200	7	38850	35	8 × 2810	2 × 2810	28100
NEBX 8002 234 12D	800	2	3 ~ 400	3200	7	37169	32	10 × 2810	2 × 2810	33720
NEBX 8002 292 12D	800	2	3 ~ 400	3200	7	35811	31	14 × 2810	2 × 2810	39340
NEBX 8003 177 12D	800	3	3 ~ 400	4800	10.5	60926	43	5 × 4420	2 × 4420	30940
NEBX 8003 265 12D	800	3	3 ~ 400	4800	10.5	58357	42	8 × 4420	2 × 4420	44200
NEBX 8003 353 12D	800	3	3 ~ 400	4800	10.5	55848	38	10 × 4420	2 × 4420	53040
NEBX 8003 442 12D	800	3	3 ~ 400	4800	10.5	53817	37	14 × 4420	2 × 4420	61880

AVAILABLE OPTIONS FOR NEBX SERIES

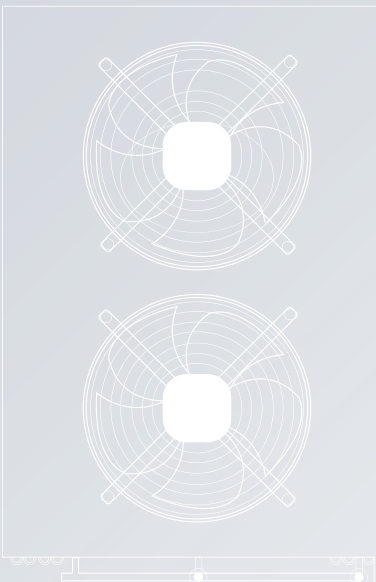
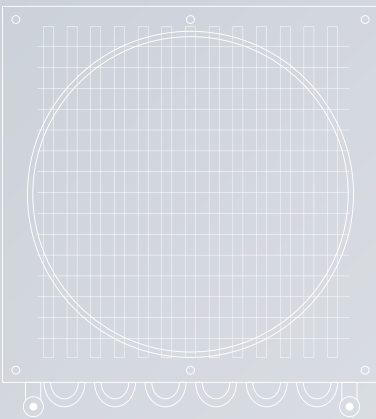
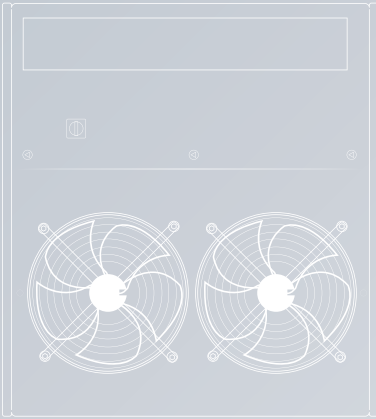
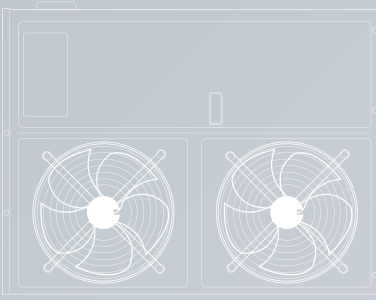

Defrost options:

- Air
- Electrical defrost
- Hot gas
- Water
- Hot gas for coil and electrical for tray
- Water and electrical



Tube material options:

- Stainless steel AISI SUS304



Coil protection options:

- Aluminium fins
- Fins with GOLDFIN anti-corrosion high resistance coating



Fan options:

- EC Fans
- Silica gel heaters for fan nozzles, only for $\varnothing 500$ mm or above
- Streamers: Airk-guiding device for increased airthrow



Casing options:

- White powder-coated painted aluminium
- Stainless steel AISI SUS304



Other options:

- Double insulated drip tray (recommended for low temperature applications)
- Thermal protector for defrosting electrical heaters

OPCIONES DISPONIBLES PARA LA SERIE NEBX



Opciones de desescarche:

- Aire
- Desescarche eléctrico
- Gas caliente
- Agua
- Aas caliente en serpentín y eléctrico en bandeja
- Agua y eléctrico



Tube material options:

- Acero inoxidable AISI SUS304



Coil protection options:

- Aleta de aluminio
- Aleta con tratamiento GOLDFIN con anticorrosión de alta resistencia



Fan options:

- Ventiladores EC
- Resistencias calefactoras para aro de ventiladores, sólo para modelos $\varnothing 500$ mm o más grandes
- Streamers: Dispositivo de aire guiado para incrementar el tiro de aire



Casing options:

- Aluminio pintado al polvo blanco
- acero inoxidable AISI SUS304



Other options:

- Bandeja de goteo con doble aislamiento (recomendada en aplicaciones con cámaras de baja temperatura)
- Protector térmico para resistencias de desescarche

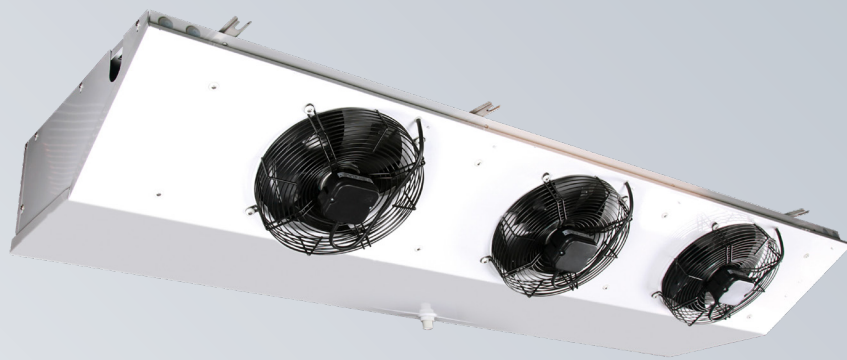

NECX & NECX PLUS SERIES EVAPORATOR

EVAPORADORES SERIE NECX & NECX PLUS

COMPACT-CEILING AIR TYPE EVAPORATORS EVAPORADORES COMPACTOS TIPO CUÑA

The NECX range of compact-ceiling air type evaporators has been designed for use in low height commercial cold room or the preservation of fresh and frozen products.

The exchange coils used in the NECX range are highly

The exchange coils used in the NECX range are built with geometries of recognized high efficiency, with special profile aluminum fins and $\varnothing 12$ mm internally grooved (NECX 25XX, NECX Plus 30XX) or $\varnothing 15$ mm (NECX 30XX) high quality SS304 tubes, with high heat transfer coefficient. They are supplied clean and tested under a pressure of 30 bar.

01

White powder-coated aluminium casing with high resistance to corrosion and impacts.

02

In models with electric defrost, stainless steel electric heaters covered by aluminum tubes are used, located in the finned package to avoid steam problems and make easy replacement.

03

The electrical parts are connected to an earth terminal, inside a connection box with access holes equipped with cable glands with IP 65 protection.

04

For performance at work points other than those in this catalog, use the "Unit Selector Hybrid HISPANIA" software.



For special applications and additional information consult our Technical Department.

NECX SERIES EVAPORATORS EVAPORADORES SERIE NECX

La gama de evaporadores tipo cuña NECX ha sido diseñada para su uso en cámaras frigoríficas comerciales de poca altura para conservación de productos frescos y congelados.

Los baterías de intercambio utilizadas en la gama NECX son

Los baterías de intercambio utilizadas en la gama NECX están construidos con geometrías de reconocida alta eficiencia, con aletas de aluminio de perfil especial y tubos de SS304 de $\varnothing 12$ mm estriado interiormente (NECX 25XX, NECX Plus 30XX) o $\varnothing 15$ mm (NECX 30XX), de alta calidad, con un alto coeficiente de transferencia de calor. Se suministran limpias y probadas a una presión de 30 bar.

01

La carcasa de aluminio pintado en blanco al polvo electrostático con alta resistencia a la corrosión y a los impactos.

02

En los modelos con desescarche eléctrico se usan resistencias en acero inoxidable cubiertas por tubos de aluminio, situados en el paquete aleteado para evitar problemas de vapor y facilitar la sustitución.

03

Las partes eléctricas están conectadas a un terminal de tierra, dentro de una caja de conexiones con orificios de acceso equipados con prensaestopas con grado de protección IP 65.

04

Para rendimientos en puntos de trabajo distintos a los de este catálogo utilizar el software "Unit Selector Hybrid HISPANIA".



Para aplicaciones especiales e informaciones adicionales consultar a nuestro Departamento Técnico.

NECX 2503 26 4D S1 2 3

● Fin materials (blank: aluminum, 3: stainless steel, GF: golden fins) / Materiales de las aletas (en blanco: aluminio, 3: acero inoxidable, GF: aletas doradas)

● Casing materials (blank: aluminum, 2: stainless steel) / Materiales de la carcasa (en blanco: aluminio, 2: acero inoxidable)

● Tube materials (1: stainless steel) / Materiales del tubo (1: acero inoxidable)

● Defrost system (blank: air, D: electric, HG: hot gas, W: water, HGD: hot gas & electric, WD: water & electric) / Sistema de descongelación (en blanco: aire, D: eléctrico, HG: gas caliente, W: agua, HGD: gas caliente y eléctrico, WD: agua y electricidad)

● Fin spacing (mm) / Espacio entre aletas (mm)

● Surface (m²) / Superficie (m²)

● Fan number / Número de ventiladores

● Fan \varnothing (mm) / Ventilador \varnothing (mm)

● Series / Serie

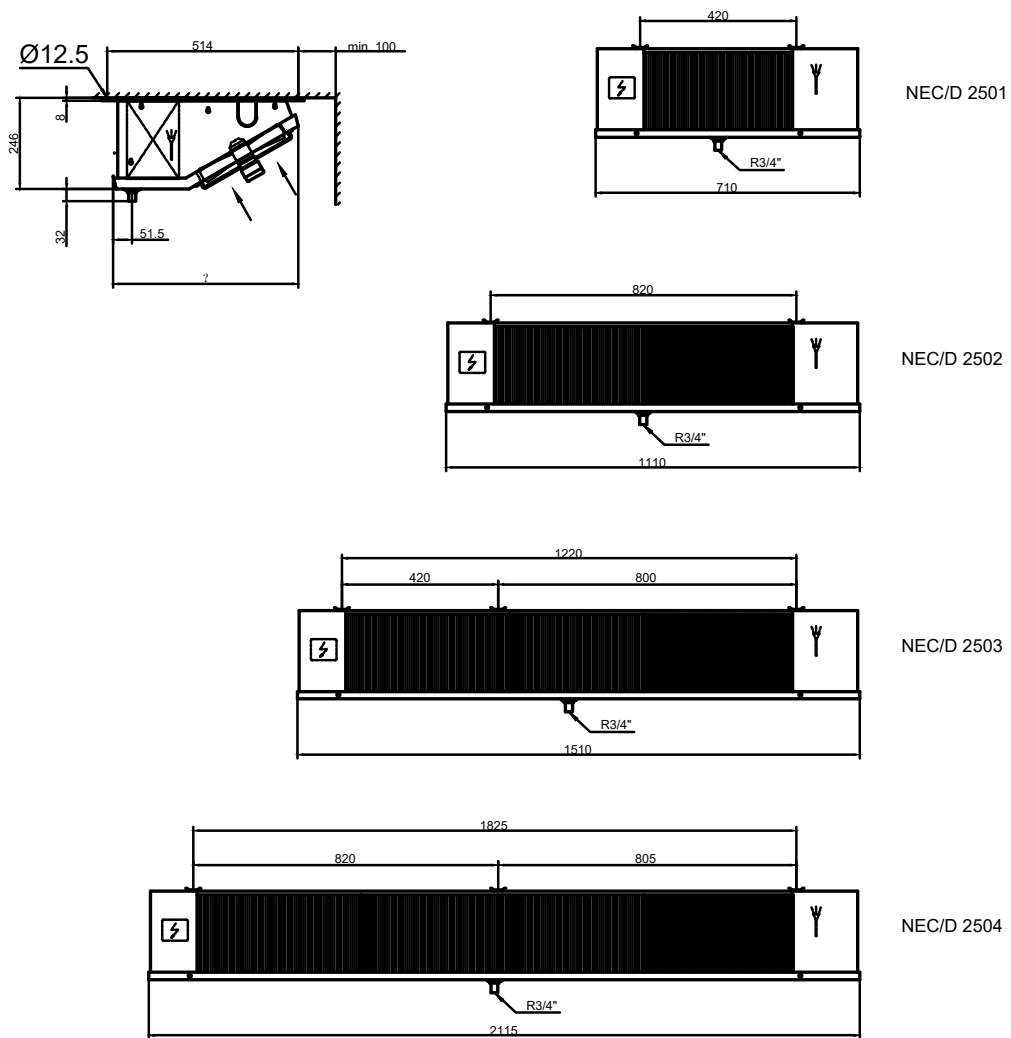

Dia. 1

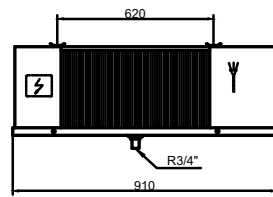
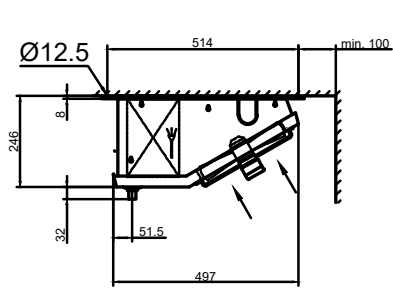

NEC/D 2501

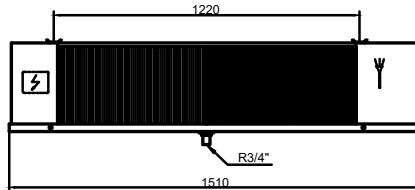

NEC/D 2502

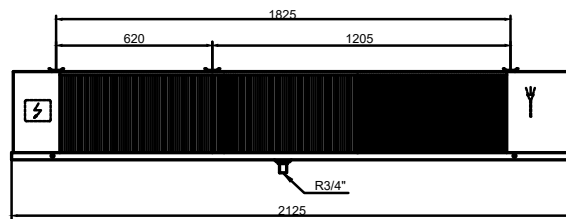

NEC/D 2503

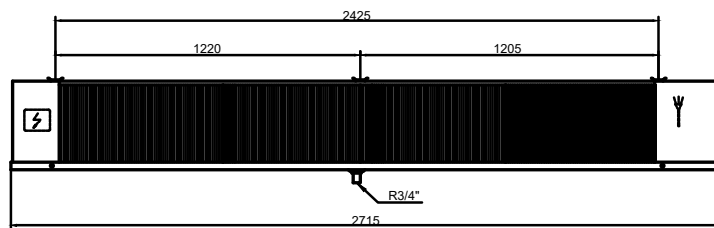

NEC/D 2504

Dia. 2

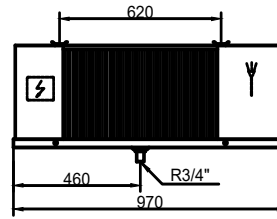
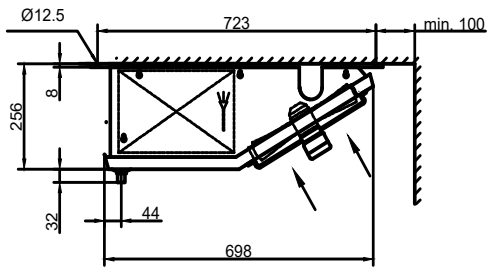

NEC/D 3001

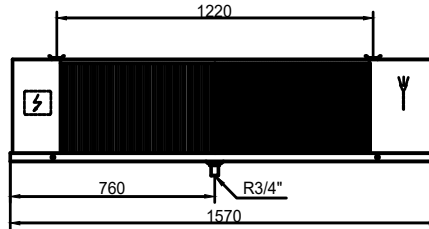

NEC/D 3002

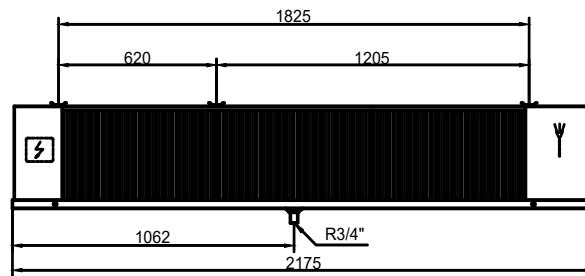

NEC/D 3003

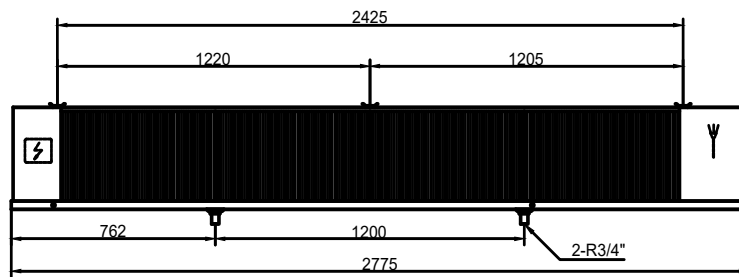

NEC/D 3004

Dia. 3

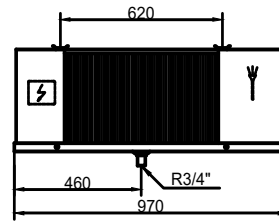
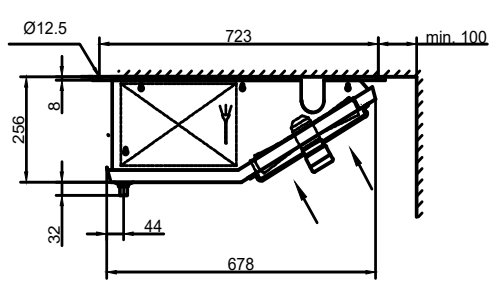

NEC/D PLUS 3001

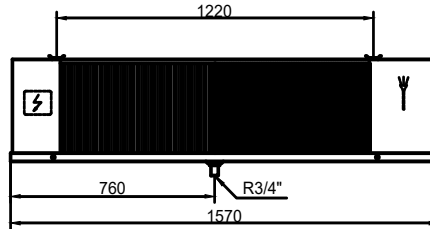

NEC/D PLUS 3002

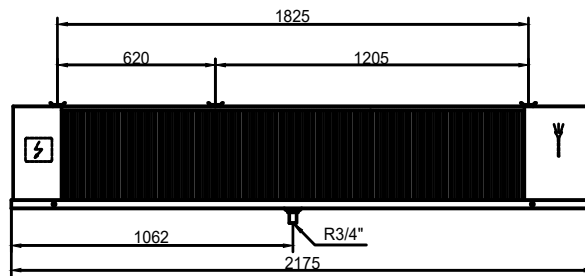

NEC/D PLUS 3003

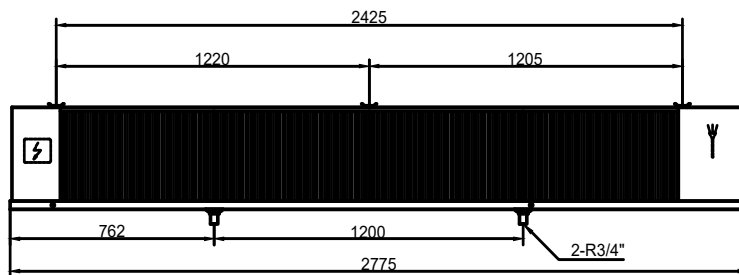

NEC/D PLUS 3004

Dia. 4

FIN SPACING 4 mm, with electrical defrost. Rt>=0°C

SEPARACIÓN ALETAS 4 mm, con desescarche eléctrico. Rt>=0°C

Modelo / Model	Capacidad / Capacity R717 (kw)		Superficie / Surface (m ²)	Volumen interno / Tube Volume (dm ³)	Peso Neto / N.W. (kg)	Conexión / Connection (ømm)		Dimensión / Dimensión
	te= 0°C	te= -8°C				Entrada / Inlet	Salida / Outlet	
	DTI=10K	DTI=8K						
NECX 2501 05 4D	1.33	0.86	4.3	0.7	14.9	DN6	DN6	Dia. 1
NECX 2501 06 4D	1.64	1.1	5.7	1	15.9	DN6	DN6	Dia. 1
NECX 2501 07 4D	2	1.33	6.4	1.1	17.3	DN6	DN6	Dia. 2
NECX 2501 09 4D	2.44	1.66	8.5	1.4	18.7	DN6	DN6	Dia. 2
NECX 2502 12 4D	3.29	2.2	11.4	1.9	25.7	DN6	DN6	Dia. 1
NECX 2502 18 4D	4.9	3.33	17.1	2.9	31.3	DN10	DN15	Dia. 2
NECX 2503 17 4D	4.93	3.3	17.1	2.9	35.5	DN10	DN15	Dia. 1
NECX 2503 26 4D	7.01	4.68	25.7	4.3	44	DN10	DN15	Dia. 2
NECX 2504 23 4D	6.58	4.41	22.9	3.8	45.7	DN10	DN15	Dia. 1
NECX 2504 34 4D	9.12	6.04	34.3	5.8	55.7	DN15	DN20	Dia. 2
NECX Plus 3001 13 4D	3.4	2.3	12.8	2.2	27.6	DN10	DN10	Dia. 4
NECX Plus 3001 17 4D	3.5	2.36	17.1	2.9	31.4	DN10	DN10	Dia. 4
NECX Plus 3002 26 4D	6.18	4.05	25.7	4.3	46.8	DN10	DN15	Dia. 4
NECX Plus 3002 34 4D	7.02	4.74	34.3	5.8	53.9	DN10	DN15	Dia. 4
NECX Plus 3003 39 4D	10.23	6.92	38.6	6.5	66.3	DN15	DN20	Dia. 4
NECX Plus 3003 51 4D	11.2	7.73	51.4	8.7	76.9	DN15	DN20	Dia. 4
NECX Plus 3004 51 4D	14.27	9.82	51.4	8.7	85.4	DN15	DN20	Dia. 4
NECX Plus 3004 69 4D	15.3	10.67	68.6	11.5	99.3	DN15	DN20	Dia. 4

Modelo / Model	Ventilador con Motor Axial / Axial Fans							Desescarche Eléctrico Electric Defrost		
	Diámetro / Diameter (ø mm)	Nº	Voltaje / Voltage (V, 50Hz)	Potencia / Power (W)	Intensidad / Current (A)	Flujo de aire / Air Flow (m3/h)	Tiro / Air Throw (m)	Aletas / Coil (W)	Desagüe / Drain Pan (W)	Total / Total (W)
NECX 2501 05 4D	250	1	1~230	50	0.2	687	5	1×400	1×400	800
NECX 2501 06 4D	250	1	1~230	50	0.2	602	4	1×400	1×400	800
NECX 2501 07 4D	250	1	1~230	50	0.2	848	4	1×550	1×550	1100
NECX 2501 09 4D	250	1	1~230	50	0.2	786	4	1×550	1×550	1100
NECX 2502 12 4D	250	2	1~230	100	0.5	1205	5	1×700	1×700	1400
NECX 2502 18 4D	250	2	1~230	100	0.5	1573	5	1×1000	1×1000	2000
NECX 2503 17 4D	250	3	1~230	150	0.7	1806	6	1×1250	1×1250	2500
NECX 2503 26 4D	250	3	1~230	150	0.7	2361	6	1×1700	1×1700	3400
NECX 2504 23 4D	250	4	1~230	200	0.9	2410	7	1×1400	1×1400	2800
NECX 2504 34 4D	250	4	1~230	200	0.9	3150	7	1×2000	1×2000	4000
NECX Plus 3001 13 4D	300	1	1~230	80	0.4	964	9	2×750	1×750	2250
NECX Plus 3001 17 4D	300	1	1~230	80	0.4	859	6	3×750	2×750	3750
NECX Plus 3002 26 4D	300	2	1~230	160	0.8	1936	10	2×1250	1×1250	3750
NECX Plus 3002 34 4D	300	2	1~230	160	0.8	1720	8	3×1250	2×1250	6250
NECX Plus 3003 39 4D	300	3	1~230	240	1.2	2897	13	2×1700	1×1700	5100
NECX Plus 3003 51 4D	300	3	1~230	240	1.2	2577	9	3×1700	2×1700	8500
NECX Plus 3004 51 4D	300	4	1~230	320	1.6	3858	15	2×2000	1×2000	6000
NECX Plus 3004 69 4D	300	4	1~230	320	1.6	3435	11	3×2000	2×2000	10000

FIN SPACING 6 mm, with electrical defrost. Rt>=-18°C

SEPARACIÓN ALETAS 6 mm, con desescarche eléctrico. Rt>=-18°C

Modelo / Model	Capacidad / Capacity R717 (kw)		Superficie / Surface (m ²)	Volumen interno / Tube Volume (dm ³)	Peso Neto / N.W. (kg)	Conexión / Connection (ømm)		Dimensión / Dimensión
	te= -8°C	te= -25°C				Entrada / Inlet	Salida / Outlet	
	DTI=8K	DTI=7K						
NECX 2501 03 6D	0.7	0.58	2.9	0.7	14.7	DN6	DN6	Dia. 1
NECX 2501 04 6D	0.94	0.74	3.9	1	15.6	DN6	DN6	Dia. 1
NECX 2501 05 6D	1.08	0.82	4.4	1.1	17.1	DN6	DN6	Dia. 2
NECX 2501 06 6D	1.4	1.04	5.9	1.4	18.4	DN6	DN6	Dia. 2
NECX 2502 08 6D	1.88	1.49	7.9	1.9	25.3	DN6	DN6	Dia. 1
NECX 2502 12 6D	2.8	2.08	11.8	2.9	30.6	DN10	DN15	Dia. 2
NECX 2503 12 6D	2.82	2.23	11.8	2.9	34.8	DN10	DN15	Dia. 1
NECX 2503 18 6D	3.92	3.01	17.7	4.3	43.1	DN10	DN15	Dia. 2
NECX 2504 16 6D	3.76	2.98	15.7	3.8	44.9	DN10	DN15	Dia. 1
NECX 2504 24 6D	5.04	3.93	23.6	5.8	54.4	DN15	DN20	Dia. 2
NECX Plus 3001 09 6D	2.04	1.58	8.8	2.2	27.1	DN10	DN10	Dia. 4
NECX Plus 3001 12 6D	2.17	1.71	11.8	2.9	30.7	DN10	DN10	Dia. 4
NECX Plus 3002 18 6D	3.53	2.9	17.7	4.3	45.9	DN10	DN15	Dia. 4
NECX Plus 3002 24 6D	4.35	3.42	23.6	5.8	52.6	DN10	DN15	Dia. 4
NECX Plus 3003 27 6D	6.14	4.78	26.5	6.5	64.9	DN15	DN20	Dia. 4
NECX Plus 3003 35 6D	7.2	5.45	35.4	8.7	75	DN15	DN20	Dia. 4
NECX Plus 3004 35 6D	8.78	6.61	35.4	8.7	83.5	DN15	DN20	Dia. 4
NECX Plus 3004 47 6D	10.01	7.54	47.2	11.5	96.7	DN15	DN20	Dia. 4

Modelo / Model	Ventilador con Motor Axial / Axial Fans							Desescarche Eléctrico Electric Defrost		
	Diámetro / Diameter (ø mm)	Nº	Voltaje / Voltage (V, 50Hz)	Potencia / Power (W)	Intensidad / Current (A)	Flujo de aire / Air Flow (m3/h)	Tiro / Air Throw (m)	Aletas / Coil (W)	Desagüe / Drain Pan (W)	Total / Total (W)
NECX 2501 03 6D	250	1	1~230	50	0.2	751	6	1×400	1×400	800
NECX 2501 04 6D	250	1	1~230	50	0.2	662	5	1×400	1×400	800
NECX 2501 05 6D	250	1	1~230	50	0.2	890	4	1×550	1×550	1100
NECX 2501 06 6D	250	1	1~230	50	0.2	831	4	1×550	1×550	1100
NECX 2502 08 6D	250	2	1~230	100	0.5	1325	5	1×700	1×700	1400
NECX 2502 12 6D	250	2	1~230	100	0.5	1664	5	1×1000	1×1000	2000
NECX 2503 12 6D	250	3	1~230	150	0.7	1987	7	1×1250	1×1250	2500
NECX 2503 18 6D	250	3	1~230	150	0.7	2498	6	1×1700	1×1700	3400
NECX 2504 16 6D	250	4	1~230	200	0.9	2652	7	1×1400	1×1400	2800
NECX 2504 24 6D	250	4	1~230	200	0.9	3333	8	1×2000	1×2000	4000
NECX Plus 3001 09 6D	300	1	1~230	80	0.4	1052	10	2×750	1×750	2250
NECX Plus 3001 12 6D	300	1	1~230	80	0.4	937	7	3×750	2×750	3750
NECX Plus 3002 18 6D	300	2	1~230	160	0.8	2114	12	2×1250	1×1250	3750
NECX Plus 3002 24 6D	300	2	1~230	160	0.8	1875	8	3×1250	2×1250	6250
NECX Plus 3003 27 6D	300	3	1~230	240	1.2	3159	14	2×1700	1×1700	5100
NECX Plus 3003 35 6D	300	3	1~230	240	1.2	2808	10	3×1700	2×1700	8500
NECX Plus 3004 35 6D	300	4	1~230	320	1.6	4207	17	2×2000	1×2000	6000
NECX Plus 3004 47 6D	300	4	1~230	320	1.6	3742	12	3×2000	2×2000	10000

FIN SPACING 9 mm, with electrical defrost. Rt>=-35°C

SEPARACIÓN ALETAS 9 mm, con desescarche eléctrico. Rt>=-35°C

Modelo / Model	Capacidad / Capacity R717 (kw)		Superficie / Surface (m ²)	Volumen interno / Tube Volume (dm ³)	Peso Neto / N.W. (kg)	Conexión / Connection (ømm)		Dimension / Dimensión
	te= -8°C	te= -25°C				Entrada / Inlet	Salida / Outlet	
	DT1=8K	DT1=7K						
NECX 2501 02 9D	0.57	0.45	2.1	0.7	14.5	DN6	DN6	Dia. 1
NECX 2501 03 9D	0.77	0.61	2.7	1	15.4	DN6	DN6	Dia. 1
NECX 2501 04 9D	1.13	0.84	4.1	1.4	17.9	DN6	DN6	Dia. 2
NECX 2502 06 9D	1.54	1.22	5.5	1.9	24.7	DN6	DN6	Dia. 1
NECX 2502 08 9D	2.27	1.69	8.2	2.9	29.8	DN10	DN15	Dia. 2
NECX 2503 08 9D	3.17	2.43	12.3	4.3	34	DN10	DN15	Dia. 1
NECX 2503 12 9D	3.1	2.45	11	3.8	41.9	DN10	DN15	Dia. 2
NECX 2504 11 9D	4.07	3.16	16.4	5.8	43.8	DN10	DN15	Dia. 1
NECX 2504 16 9D	1.74	1.34	6.2	2.2	52.8	DN15	DN20	Dia. 2
NECX Plus 3001 06 9D	1.91	1.51	8.2	2.9	26.5	DN10	DN10	Dia. 4
NECX Plus 3001 08 9D	2.97	2.44	12.3	4.3	29.9	DN10	DN10	Dia. 4
NECX Plus 3002 12 9D	3.84	3.02	16.4	5.8	44.7	DN10	DN15	Dia. 4
NECX Plus 3002 16 9D	5.23	4.05	18.5	6.5	51	DN10	DN15	Dia. 4
NECX Plus 3003 19 9D	6.42	4.83	24.7	8.7	63	DN15	DN20	Dia. 4
NECX Plus 3003 25 9D	7.51	5.64	24.7	8.7	72.5	DN15	DN20	Dia. 4
NECX Plus 3004 25 9D	8.98	6.72	32.9	11.5	81	DN15	DN20	Dia. 4
NECX Plus 3004 33 9D	8.41	5.88	32.9	11.5	93.5	DN15	DN20	Dia. 4

Modelo / Model	Ventilador con Motor Axial / Axial Fans							Desescarche Eléctrico Electric Defrost		
	Diámetro / Diameter (ø mm)	Nº	Voltaje / Voltage (V, 50Hz)	Potencia / Power (W)	Intensidad / Current (A)	Flujo de aire / Air Flow (m3/h)	Tiro / Air Throw (m)	Aletas / Coil (W)	Desagüe / Drain Pan (W)	Total / Total (W)
NECX 2501 02 9D	250	1	1 ~ 230	50	0.2	799	6	1 × 400	1 × 400	800
NECX 2501 03 9D	250	1	1 ~ 230	50	0.2	721	4	1 × 400	1 × 400	800
NECX 2501 04 9D	250	1	1 ~ 230	50	0.2	872	4	1 × 550	1 × 550	1100
NECX 2502 06 9D	250	2	1 ~ 230	100	0.5	1443	5	1 × 550	1 × 550	1100
NECX 2502 08 9D	250	2	1 ~ 230	100	0.5	1745	5	1 × 700	1 × 700	1400
NECX 2503 08 9D	250	3	1 ~ 230	150	0.7	2628	7	1 × 1700	1 × 1700	3400
NECX 2503 12 9D	250	4	1 ~ 230	200	0.9	2903	8	1 × 1400	1 × 1400	2800
NECX 2504 11 9D	250	4	1 ~ 230	200	0.9	3506	8	1 × 2000	1 × 2000	4000
NECX 2504 16 9D	300	1	1 ~ 230	80	0.4	1142	10	2 × 750	1 × 750	2250
NECX Plus 3001 06 9D	300	1	1 ~ 230	80	0.4	1023	7	3 × 750	2 × 750	3750
NECX Plus 3001 08 9D	300	2	1 ~ 230	160	0.8	2297	9	2 × 1250	1 × 1250	3750
NECX Plus 3002 12 9D	300	2	1 ~ 230	160	0.8	2047	11	3 × 1250	2 × 1250	6250
NECX Plus 3002 16 9D	300	3	1 ~ 230	240	1.2	3430	14	2 × 1700	1 × 1700	5100
NECX Plus 3003 19 9D	300	3	1 ~ 230	240	1.2	3064	10	3 × 1700	2 × 1700	8500
NECX Plus 3003 25 9D	300	4	1 ~ 230	320	1.6	4566	17	2 × 2000	1 × 2000	6000
NECX Plus 3004 25 9D	300	4	1 ~ 230	320	1.6	4083	12	3 × 2000	2 × 2000	10000
NECX Plus 3004 33 9D	300	4	1 ~ 230	320	1.6	4081	12	3 × 2000	2 × 2000	10000

FIN SPACING 4.5 mm, with electrical defrost. Rt>=0°C
SEPARACIÓN ALETAS 4.5 mm, con desescarche eléctrico. Rt>=0°C

Modelo / Model	Capacidad / Capacity R717 (kw)		Superficie / Surface (m ²)	Volumen interno / Tube Volume (dm ³)	Peso Neto / N.W. (kg)	Conexión / Connection (ømm)		Dimension / Dimensión
	te= 0°C	te= -8°C				Entrada / Inlet	Salida / Outlet	
	DTI=10K	DTI=8K						
NECX 3001 11 4.5D	1.71	1.1	10.4	1.5	24.8	DN8	DN8	Dia. 3
NECX 3001 16 4.5D	2.56	1.64	15.5	2.2	27.7	DN8	DN8	Dia. 3
NECX 3002 21 4.5D	4.7	3.05	20.8	3	41.5	DN8	DN8	Dia. 3
NECX 3002 32 4.5D	5.13	3.29	31.1	4.5	47	DN8	DN8	Dia. 3
NECX 3003 32 4.5D	6.3	3.97	31.1	4.5	58.4	DN10	DN15	Dia. 3
NECX 3003 48 4.5D	8.78	5.83	46.7	6.8	67.1	DN15	DN20	Dia. 3
NECX 3004 43 4.5D	9.39	6.11	41.5	6	75.5	DN15	DN20	Dia. 3
NECX 3004 64 4.5D	11.33	7.46	62.3	9	86.4	DN15	DN20	Dia. 3

Modelo / Model	Ventilador con Motor Axial / Axial Fans							Desescarche Eléctrico Electric Defrost		
	Diámetro / Diameter (ø mm)	Nº	Voltaje / Voltage (V, 50Hz)	Potencia / Power (W)	Intensidad / Current (A)	Flujo de aire / Air Flow (m3/h)	Tiro / Air Throw (m)	Aletas / Coil (W)	Desagüe / Drain Pan (W)	Total / Total (W)
NECX 3001 11 4.5D	300	1	1~ 230	80	0.4	1177	9	2 × 700	1 × 700	2100
NECX 3001 16 4.5D	300	1	1~ 230	80	0.4	989	6	2 × 700	1 × 700	2100
NECX 3002 21 4.5D	300	2	1~ 230	160	0.8	2314	10	2 × 1030	1 × 1030	3090
NECX 3002 32 4.5D	300	2	1~ 230	160	0.8	1979	8	2 × 1030	1 × 1030	3090
NECX 3003 32 4.5D	300	3	1~ 230	240	1.2	3493	13	2 × 1700	1 × 1700	5100
NECX 3003 48 4.5D	300	3	1~ 230	240	1.2	2952	9	2 × 1700	1 × 1700	5100
NECX 3004 43 4.5D	300	4	1~ 230	320	1.6	4629	15	2 × 2000	1 × 2000	6000
NECX 3004 64 4.5D	300	4	1~ 230	320	1.6	3942	11	2 × 2000	1 × 2000	6000

FIN SPACING 7 mm, with electrical defrost. Rt>=-20°C
SEPARACIÓN ALETAS 7 mm, con desescarche eléctrico. Rt>=-20°C

Modelo / Model	Capacidad / Capacity R717 (kw)		Superficie / Surface (m ²)	Volumen interno / Tube Volume (dm ³)	Peso Neto / N.W. (kg)	Conexión / Connection (ømm)		Dimensión / Dimensión
	te= -8°C	te= -25°C				Entrada / Inlet	Salida / Outlet	
	DT1=8K	DT1=7K						
NECX 3001 07 7D	0.84	0.74	6.8	1.5	24.1	DN8	DN8	Dia. 3
NECX 3001 10 7D	1.33	1.17	10.2	2.2	26.5	DN8	DN8	Dia. 3
NECX 3002 14 7D	2.38	2	13.7	3	39.9	DN8	DN8	Dia. 3
NECX 3002 20 7D	2.67	2.35	20.5	4.5	44.7	DN8	DN8	Dia. 3
NECX 3003 20 7D	3.05	2.71	20.5	4.5	56.1	DN10	DN15	Dia. 3
NECX 3003 30 7D	4.86	3.99	30.8	6.8	63.7	DN15	DN20	Dia. 3
NECX 3004 28 7D	4.77	4.01	27.4	6	72.5	DN15	DN20	Dia. 3
NECX 3004 41 7D	6.17	5.17	41	9	81.8	DN15	DN20	Dia. 3

Modelo / Model	Ventilador con Motor Axial / Axial Fans							Desescarche Eléctrico Electric Defrost		
	Diámetro / Diameter (ø mm)	Nº	Voltaje / Voltage (V, 50Hz)	Potencia / Power (W)	Intensidad / Current (A)	Flujo de aire / Air Flow (m ³ /h)	Tiro / Air Throw (m)	Aletas / Coil (W)	Desagüe / Drain Pan (W)	Total / Total (W)
NECX 3001 07 7D	300	1	1 ~ 230	80	0.4	1268	10	2 × 700	1 × 700	2100
NECX 3001 10 7D	300	1	1 ~ 230	80	0.4	1093	7	2 × 700	1 × 700	2100
NECX 3002 14 7D	300	2	1 ~ 230	160	0.8	2496	12	2 × 1030	1 × 1030	3090
NECX 3002 20 7D	300	2	1 ~ 230	160	0.8	2187	8	2 × 1030	1 × 1030	3090
NECX 3003 20 7D	300	3	1 ~ 230	240	1.2	3766	14	2 × 1700	1 × 1700	5100
NECX 3003 30 7D	300	3	1 ~ 230	240	1.2	3256	10	2 × 1700	1 × 1700	5100
NECX 3004 28 7D	300	4	1 ~ 230	320	1.6	4992	17	2 × 2000	1 × 2000	6000
NECX 3004 41 7D	300	4	1 ~ 230	320	1.6	4350	12	2 × 2000	1 × 2000	6000

FIN SPACING 10 mm, with electrical defrost. Rt>=-35°C
SEPARACIÓN ALETAS 10 mm, con desescarche eléctrico. Rt>=-35°C

Modelo / Model	Capacidad / Capacity R717 (kw)		Superficie / Surface (m²)	Volumen interno / Tube Volume (dm³)	Peso Neto / N.W. (kg)	Conexión / Connection (ømm)		Dimension / Dimensión
	te= -8°C	te= -25°C				Entrada / Inlet	Salida / Outlet	
	DT1=8K	DT1=7K						
NECX 3001 05 10D	0.67	0.59	4.9	1.5	23.7	DN8	DN8	Dia. 3
NECX 3001 07 10D	1.13	0.99	7.4	2.2	26	DN8	DN8	Dia. 3
NECX 3002 10 10D	1.95	1.64	9.8	3	39.2	DN8	DN8	Dia. 3
NECX 3002 15 10D	2.25	1.98	14.8	4.5	43.5	DN8	DN8	Dia. 3
NECX 3003 15 10D	2.48	2.21	14.8	4.5	54.9	DN10	DN15	Dia. 3
NECX 3003 22 10D	4.15	3.41	22.1	6.8	61.9	DN15	DN20	Dia. 3
NECX 3004 20 10D	3.9	3.29	19.7	6	70.9	DN15	DN20	Dia. 3
NECX 3004 29 10D	5.25	4.4	29.5	9	79.5	DN15	DN20	Dia. 3

Modelo / Model	Ventilador con Motor Axial / Axial Fans							Desescarche Eléctrico / Electric Defrost		
	Diámetro / Diameter (ø mm)	Nº	Voltaje / Voltage (V, 50Hz)	Potencia / Power (W)	Intensidad / Current (A)	Flujo de aire / Air Flow (m3/h)	Tiro / Air Throw (m)	Aletas / Coil (W)	Desagüe / Drain Pan (W)	Total / Total (W)
NECX 3001 05 10D	300	1	1~ 230	80	0.4	1333	10	2 × 700	1 × 700	2100
NECX 3001 07 10D	300	1	1~ 230	80	0.4	1178	7	2 × 700	1 × 700	2100
NECX 3002 10 10D	300	2	1~ 230	160	0.8	2621	9	2 × 1030	1 × 1030	3090
NECX 3002 15 10D	300	2	1~ 230	160	0.8	2357	11	2 × 1030	1 × 1030	3090
NECX 3003 15 10D	300	3	1~ 230	240	1.2	3956	14	2 × 1700	1 × 1700	5100
NECX 3003 22 10D	300	3	1~ 230	240	1.2	3502	10	2 × 1700	1 × 1700	5100
NECX 3004 20 10D	300	4	1~ 230	320	1.6	5243	17	2 × 2000	1 × 2000	6000
NECX 3004 29 10D	300	4	1~ 230	320	1.6	4681	12	2 × 2000	1 × 2000	6000

AVAILABLE OPTIONS FOR NECX SERIES



Defrost options:

- Air
- Electrical defrost
- Hot gas
- Water
- Hot gas for coil and electrical for tray
- Water and electrical



Tube material options:

- Stainless steel AISI SUS304



Coil protection options:

- Aluminium fins
- Fins with GOLDFIN anti-corrosion high resistance coating



Fan options:

- EC Fans



Casing options:

- White powder-coated painted aluminium
- Stainless steel AISI SUS304



Other options:

- Thermal protector for defrosting electrical heaters

OPCIONES DISPONIBLES PARA LA SERIE NECX



Opciones de desescarche:

- Aire
- Desescarche eléctrico
- Gas caliente
- Agua
- Aas caliente en serpentín y eléctrico en bandeja
- Agua y eléctrico



Tube material options:

- Acero inoxidable AISI SUS304



Coil protection options:

- Aleta de aluminio
- Aleta con tratamiento GOLDFIN con anticorrosión de alta resistencia



Fan options:

- Ventiladores EC



Casing options:

- Aluminio pintado al polvo blanco
- acero inoxidable AISI SUS304



Other options:

- Protector térmico para resistencias de desescarche

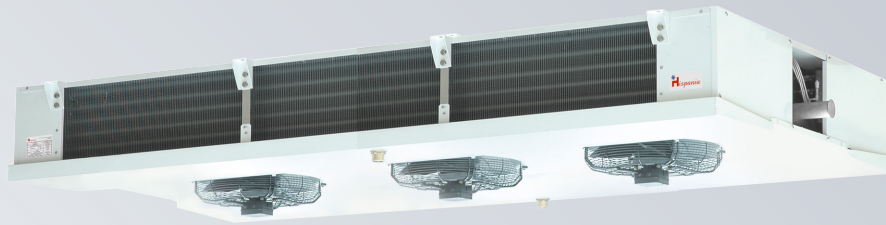

NEDX & NEDX PLUS SERIES EVAPORATOR

EVAPORADORES SERIE NEDX & NEDX PLUS

DUAL DISCHARGE CEILING AIR TYPE EVAPORATORS EVAPORADORES TIPO TECHO

The NEDX & NEDX Plus range of compact-ceiling air type evaporators has been designed for use in low/medium height cold rooms for the preservation of fresh and frozen products and processing rooms as well.

The exchange coils used in the NEDX & NEDX PLUS range are highly

The exchange coils used in the NEDX & NEDX Plus range are built with geometries of recognized high efficiency, with special profile aluminum fins and $\varnothing 12$ mm (NEDX 35XX) internally grooved or $\varnothing 15$ mm (NEDX 40XX and above) high quality SS304 tubes, with high heat transfer coefficient. They are supplied clean and tested under a pressure of 30 bar.

01

White powder-coated aluminium casing with high resistance to corrosion and impacts.

02

In models with electric defrost, stainless steel electric heaters covered by aluminum tubes are used, located in the finned package to avoid steam problems and make easy replacement.

03

The electrical parts are connected to an earth terminal, inside a connection box with access holes equipped with cable glands with IP 65 protection.

04

For performance at work points other than those in this catalog, use the "Unit Selector Hybrid HISPANIA" software.



For special applications and additional information consult our Technical Department.

NEDX SERIES EVAPORATOR EVAPORADORES SERIE NEDX

La gama de evaporadores tipo techo NEDX & NEDX Plus ha sido diseñada para su uso en cámaras frigoríficas de poca/media altura para conservación de productos frescos y congelados, así como salas de trabajo.

Los baterías de intercambio utilizadas en la gama NEDX & NEDX PLUS son

Las bobinas de intercambio utilizadas en la gama NEDX & NEDX Plus están construidas con geometrías de reconocida alta eficiencia, con aletas de aluminio de perfil especial y tubos de SS304 de alta calidad de $\varnothing 12$ mm (NEDX 35XX) ranurados internamente o de $\varnothing 15$ mm (NEDX 40XX y superior), con alto coeficiente de transferencia de calor.

01

La carcasa de aluminio pintado en blanco al polvo electrostático con alta resistencia a la corrosión y a los impactos.

02

En los modelos con desescarche eléctrico se usan resistencias en acero inoxidable cubiertas por tubos de aluminio, situados en el paquete aleteado para evitar problemas de vapor y facilitar la sustitución.

03

Las partes eléctricas están conectadas a un terminal de tierra, dentro de una caja de conexiones con orificios de acceso equipados con prensaestopas con grado de protección IP 65.

04

Para rendimientos en puntos de trabajo distintos a los de este catálogo utilizar el software "Unit Selector Hybrid HISPANIA".



Para aplicaciones especiales e informaciones adicionales consultar a nuestro Departamento Técnico.

NEDX 3502 31 4LD S1 2 3

Fin materials (blank: aluminum, 3: stainless steel, GF: golden fins) / Materiales de las aletas (en blanco: aluminio, 3: acero inoxidable, GF: aletas doradas)

Casing materials (blank: aluminum, 2: stainless steel) / Materiales de la carcasa (en blanco: aluminio, 2: acero inoxidable)

Tube materials (1: stainless steel) / Materiales del tubo (1: acero inoxidable)

Defrost system (blank: air, D: electric, HG: hot gas, W: water, HGD: hot gas & electric, WD: water & electric) / Sistema de descongelación (en blanco: aire, D: eléctrico, HG: gas caliente, W: agua, HGD: gas caliente y eléctrico, WD: agua y electricidad)

L: Low speed, N: High speed /
L: Velocidad baja, N: Velocidad alta

Fin spacing (mm) / Espacio entre aletas (mm)

Surface (m²) / Superficie (m²)

Fan number / Número de ventiladores

Fan \varnothing (mm) / Ventilador \varnothing (mm)

Series / Serie

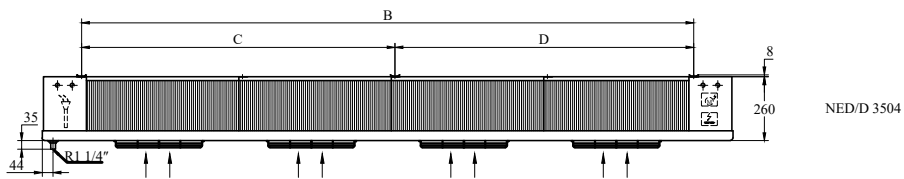
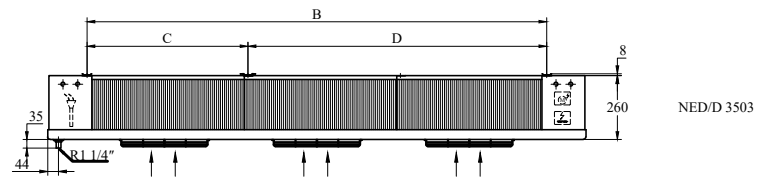
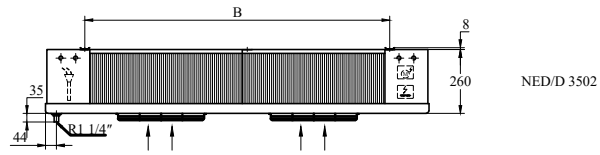
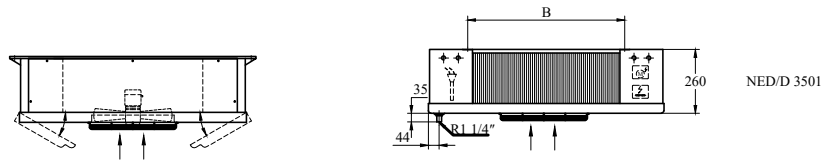
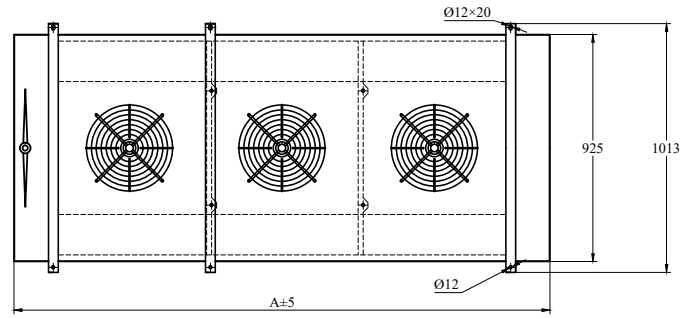

Model / Model	Dimensions / dimensiones(mm)			
	A	B	C	D
NEDX 3501...	963	640		
NEDX 3502...	1565	1242		
NEDX 3503...	2167	1844	640	1204
NEDX 3504...	2769	2446	1242	1204

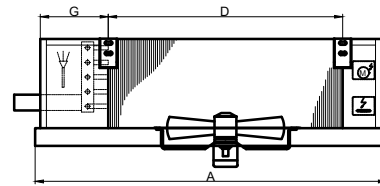
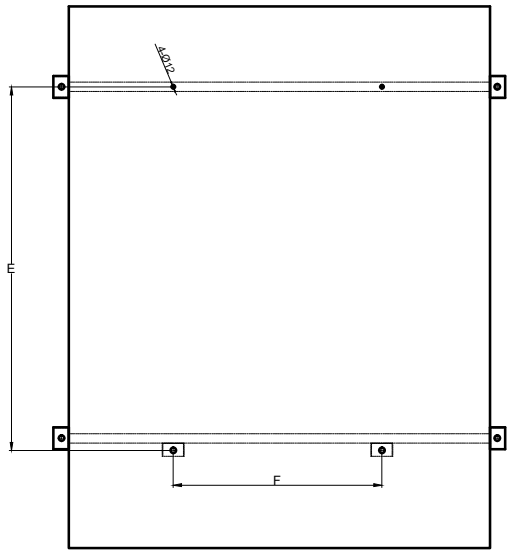
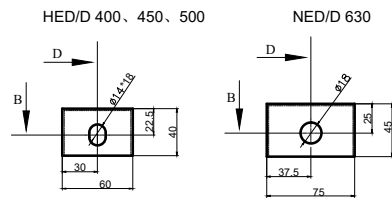
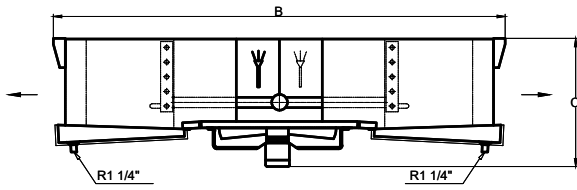

NED/D
4001/4501/5001/6301

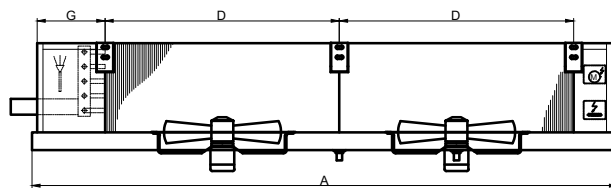

NED/D
4002/4502/5002/6302

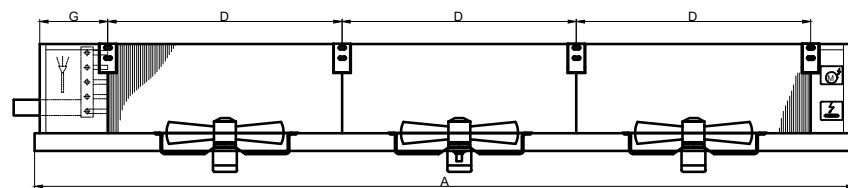

HED/D
4003/4503/5003/6303

Model / Model	Dimensions / dimensiones(mm)						
	A	B	C	D	E	F	G
NEDX 4001...	1050	1555	435	600	655	565	240
NEDX 4002...	1650	1555	435	600	1255	565	240
NEDX 4003...	2330	1555	435	600	1855	565	280
NEDX 4501...	1250	1555	450	800	855	565	240
NEDX 4502...	2050	1555	450	800	1655	565	240
NEDX 4503...	2930	1555	450	800	2455	565	280
NEDX 5001...	1530	1555	450	1000	1055	565	280
NEDX 5002...	2530	1555	450	1000	2055	565	280
NEDX 5003...	3580	1555	450	1000	3055	565	300
NEDX 6301...	1900	1935	450	1200	1255	745	365
NEDX 6302...	3100	1935	450	1200	2455	745	365
NEDX 6303...	4300	1935	450	1200	3655	745	365
*NEDX 6301...	1900	1935	550	1200	1255	745	365
*NEDX 6302...	3100	1935	550	1200	2455	745	365
*NEDX 6303...	4300	1935	550	1200	3655	745	365

Dimensions for models with *.

Dimensiones para modelos con *.

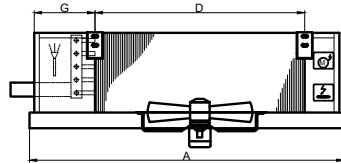
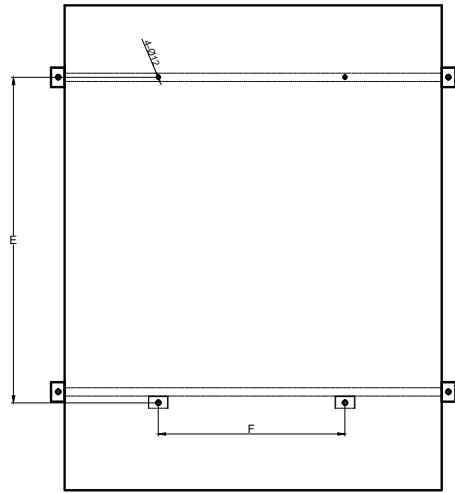
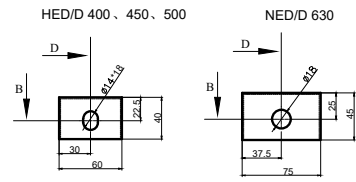
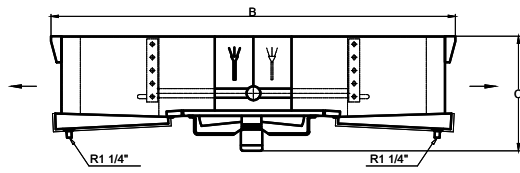

NED/D
4001/4501/5001/6301

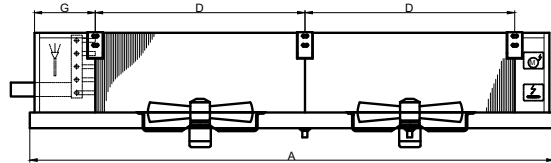

NED/D
4002/4502/5002/6302

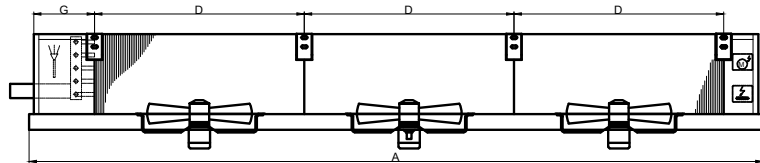

HED/D
4003/4503/5003/6303

Model / Model	Dimensions / dimensiones(mm)						
	A	B	C	D	E	F	G
NEDX Plus 4001...	1050	1390	415	600	655	565	240
NEDX Plus 4002...	1690	1390	415	600	1255	565	260
NEDX Plus 4003...	2330	1390	415	600	1855	565	280
NEDX Plus 4004...	2330	1390	415	600	2455	565	280
NEDX Plus 4501...	1250	1390	430	800	855	565	240
NEDX Plus 4502...	2090	1390	430	800	1655	565	260
NEDX Plus 4503...	2930	1390	430	800	2455	565	280
NEDX Plus 4504...	3730	1390	430	800	3255	565	280
NEDX Plus 5001...	1530	1530	430	1000	1055	565	280
NEDX Plus 5002...	2530	1530	430	1000	2055	565	280
NEDX Plus 5003...	3570	1530	430	1000	3055	565	300
NEDX Plus 5004...	4570	1530	430	1000	4055	565	300
NEDX Plus 6301...	1900	1705	570	1200	1255	745	365
NEDX Plus 6302...	3100	1705	570	1200	2455	745	365
NEDX Plus 6303...	4400	1705	570	1200	3655	745	415
NEDX Plus 6304...	5600	1705	570	1200	4855	745	415
NEDX Plus 8001...	2100	2020	750	1400	1455	1060	365
NEDX Plus 8002...	3500	2020	750	1400	2855	1060	365
NEDX Plus 8003...	4900	2020	750	1400	4255	1060	365

FIN SPACING 4 mm, with electrical defrost. Rt>=0°C

SEPARACIÓN ALETAS 4 mm, con desescarche eléctrico. Rt>=0°C

Modelo / Model	Capacidad / Capacity R717 (kw)		Superficie / Surface (m ²)	Volumen interno / Tube Volume (dm ³)	Peso Neto / N.W. (kg)	Conexión / Connection (ømm)	
	te= 0°C	te= -8°C				Entrada / Inlet	Salida / Outlet
	DTI=10K	DTI=8K					
NEDX 3501 16 4LD	3.93	2.72	17	2.9	41	DN10	DN10
NEDX 3501 16 4ND	5.53	3.69	17	2.9	41	DN10	DN15
NEDX 3502 31 4LD	7.89	5.45	34.1	5.7	68.3	DN10	DN15
NEDX 3502 31 4ND	11.1	7.42	34.1	5.7	68.3	DN15	DN20
NEDX 3503 47 4LD	11.85	8.19	51.2	8.6	96.3	DN15	DN20
NEDX 3503 47 4ND	16.66	11.15	51.2	8.6	96.3	DN15	DN20
NEDX 3504 62 4LD	15.81	10.92	68.3	11.5	122.5	DN15	DN20
NEDX 3504 62 4ND	22.23	14.87	68.3	11.5	122.5	DN20	DN25

Modelo / Model	Ventilador con Motor Axial / Axial Fans							Desescarche Eléctrico Electric Defrost	
	Diámetro / Diameter (ø mm)	Nº	Voltaje / Voltage (V, 50Hz)	Potencia / Power (W)	Intensidad / Current (A)	Flujo de aire / Air Flow (m ³ /h)	Tiro / Air Throw (m)	Aletas / Coil (W)	Total / Total (W)
NEDX 3501 16 4LD	350	1	1 ~ 230	94	0.4	1118	2 × 6	4 × 320	1280
NEDX 3501 16 4ND	350	1	1 ~ 230	150	0.7	1834	2 × 9	4 × 320	1280
NEDX 3502 31 4LD	350	2	1 ~ 230	188	0.9	2239	2 × 7	4 × 585	2340
NEDX 3502 31 4ND	350	2	1 ~ 230	300	1.5	3668	2 × 10	4 × 585	2340
NEDX 3503 47 4LD	350	3	1 ~ 230	282	1.3	3360	2 × 8	4 × 850	3400
NEDX 3503 47 4ND	350	3	1 ~ 230	450	2.2	5502	2 × 11	4 × 850	3400
NEDX 3504 62 4LD	350	4	1 ~ 230	376	1.7	4481	2 × 9	4 × 1050	4200
NEDX 3504 62 4ND	350	4	1 ~ 230	600	2.9	7337	2 × 12	4 × 1050	4200

FIN SPACING 6 mm, with electrical defrost. Rt>=-18°C

SEPARACIÓN ALETAS 6 mm, con desescarche eléctrico. Rt>=-18°C

Modelo / Model	Capacidad / Capacity R717 (kw)		Superficie / Surface (m ²)	Volumen interno / Tube Volume (dm ³)	Peso Neto / N.W. (kg)	Conexión / Connection (ømm)	
	te= -8°C	te= -25°C				Entrada / Inlet	Salida / Outlet
	DT1=8K	DT1=7K					
NEDX 3501 11 6LD	3.46	2.34	11.7	2.9	40.4	DN10	DN10
NEDX 3501 11 6ND	4.55	3.02	11.7	2.9	40.4	DN10	DN15
NEDX 3502 22 6LD	6.93	4.7	23.5	5.7	67	DN10	DN15
NEDX 3502 22 6ND	9.12	6.07	23.5	5.7	67	DN15	DN20
NEDX 3503 32 6LD	10.41	7.06	35.2	8.6	94.3	DN15	DN20
NEDX 3503 32 6ND	13.69	9.11	35.2	8.6	94.3	DN15	DN20
NEDX 3504 43 6LD	13.88	9.41	47	11.5	119.9	DN15	DN20
NEDX 3504 43 6ND	18.27	12.16	47	11.5	119.9	DN20	DN25

Modelo / Model	Ventilador con Motor Axial / Axial Fans							Desescarche Eléctrico Electric Defrost	
	Diámetro / Diameter (ø mm)	Nº	Voltaje / Voltage (V, 50Hz)	Potencia / Power (W)	Intensidad / Current (A)	Flujo de aire / Air Flow (m ³ /h)	Tiro / Air Throw (m)	Aletas / Coil (W)	Total / Total (W)
NEDX 3501 11 6LD	350	1	1 ~ 230	94	0.4	1230	2 × 6	4 × 320	1280
NEDX 3501 11 6ND	350	1	1 ~ 230	150	0.7	1867	2 × 9	4 × 320	1280
NEDX 3502 22 6LD	350	2	1 ~ 230	188	0.9	2462	2 × 7	4 × 585	2340
NEDX 3502 22 6ND	350	2	1 ~ 230	300	1.5	3735	2 × 10	4 × 585	2340
NEDX 3503 32 6LD	350	3	1 ~ 230	282	1.3	3695	2 × 8	4 × 850	3400
NEDX 3503 32 6ND	350	3	1 ~ 230	450	2.2	5603	2 × 11	4 × 850	3400
NEDX 3504 43 6LD	350	4	1 ~ 230	376	1.7	4927	2 × 9	4 × 1050	4200
NEDX 3504 43 6ND	350	4	1 ~ 230	600	2.9	7470	2 × 12	4 × 1050	4200

FIN SPACING 4 mm, with electrical defrost. Rt>=0°C

SEPARACIÓN ALETAS 4 mm, con desescarche eléctrico. Rt>=0°C

Modelo / Model	Capacidad / Capacity R717 (kw)		Superficie / Surface (m ²)	Volumen interno / Tube Volume (dm ³)	Peso Neto / N.W. (kg)	Conexión / Connection (ømm)	
	te= 0°C	te= -8°C				Entrada / Inlet	Salida / Outlet
	DTI=10K	DTI=8K					
NEDX 4001 36 4D	6.38	4.02	34.7	4.2	91.6	DN15	DN20
NEDX 4002 72 4D	15.31	10.22	69.5	8.5	149.5	DN20	DN25
NEDX 4003 108 4D	22.33	15.4	104.3	12.7	202.3	DN25	DN32
NEDX 4501 48 4D	9.82	6.37	46.3	5.6	103.4	DN15	DN20
NEDX 4502 96 4D	20.96	14.46	92.7	11.3	173.2	DN25	DN32
NEDX 4503 144 4D	32.1	21.55	139.1	17	236.9	DN25	DN32
NEDX 5001 90 4D	18.95	12.96	86.9	10.6	139.8	DN20	DN25
NEDX 5002 180 4D	38.28	26.22	173.9	21.2	245.3	DN25	DN32
NEDX 5003 270 4D	57.6	39.49	260.9	31.8	339.6	DN32	DN40
NEDX 6301 144 4D	30.02	20.39	138.9	16.9	220.9	DN25	DN32
NEDX 6302 288 4D	59.75	41.5	278.2	33.9	388.9	DN32	DN40
NEDX 6303 432 4D	88.15	61.61	417.4	50.9	545.4	DN40	DN50

Modelo / Model	Ventilador con Motor Axial / Axial Fans							Desescarche Eléctrico Electric Defrost		
	Diámetro / Diameter (ø mm)	Nº	Voltaje / Voltage (V, 50Hz)	Potencia / Power (W)	Intensidad / Current (A)	Flujo de aire / Air Flow (m3/h)	Tiro / Air Throw (m)	Aletas / Coil (W)	Desagüe / Drain Pan (W)	Total / Total (W)
NEDX 4001 36 4D	400	1	1 ~ 230	177	0.3	3174	2 × 5	4 × 700	2 × 700	4200
NEDX 4002 72 4D	400	2	1 ~ 230	354	0.6	6328	2 × 7	4 × 1510	2 × 1510	9060
NEDX 4003 108 4D	400	3	1 ~ 230	531	0.9	9486	2 × 8	4 × 1700	2 × 1700	10200
NEDX 4501 48 4D	450	1	3 ~ 400	350	1.1	4626	2 × 7	4 × 850	2 × 850	5100
NEDX 4502 96 4D	450	2	3 ~ 400	700	2.2	9221	2 × 9	4 × 1800	2 × 1800	10800
NEDX 4503 144 4D	450	3	3 ~ 400	1050	3.3	13848	2 × 11	4 × 2740	2 × 2740	16440
NEDX 5001 90 4D	500	1	3 ~ 400	577	1.4	6612	2 × 9	4 × 1280	4 × 1280	10240
NEDX 5002 180 4D	500	2	3 ~ 400	1154	2.8	13229	2 × 10	4 × 2320	4 × 2320	18560
NEDX 5003 270 4D	500	3	3 ~ 400	1731	4.1	19845	2 × 13	4 × 3200	4 × 3200	25600
NEDX 6301 144 4D	630	1	3 ~ 400	1118	2.3	9375	2 × 9	6 × 1510	4 × 1510	15100
NEDX 6302 288 4D	630	2	3 ~ 400	2236	4.5	18739	2 × 11	6 × 2740	4 × 2740	27400
NEDX 6303 432 4D	630	3	3 ~ 400	3354	6.8	28105	2 × 13	6 × 3800	4 × 3800	38000

FIN SPACING 7 mm, with electrical defrost. Rt>=-20°C

SEPARACIÓN ALETAS 7 mm, con desescarche eléctrico. Rt>=-20°C

Modelo / Model	Capacidad / Capacity R717 (kw)		Superficie / Surface (m ²)	Volumen interno / Tube Volume (dm ³)	Peso Neto / N.W. (kg)	Conexión / Connection (ømm)	
	te= -8°C	te= -25°C				Entrada / Inlet	Salida / Outlet
	DTI=8K	DTI=7K					
NEDX 4001 31 7D	4.74	3.8	30.6	6.3	96.6	DN15	DN20
NEDX 4002 62 7D	10.81	7.54	61.3	12.7	158.8	DN20	DN25
NEDX 4003 93 7D	15.15	9.43	92	19.1	216	DN25	DN32
NEDX 4501 41 7D	7.2	5.51	40.8	8.5	109.9	DN15	DN20
NEDX 4502 82 7D	14.46	9.31	81.8	17	185.3	DN25	DN32
NEDX 4503 123 7D	22.76	16.02	122.7	25.5	254.5	DN25	DN32
NEDX 5001 51 7D	10.48	7.61	51.1	10.6	131.2	DN20	DN25
NEDX 5002 103 7D	21.15	15.45	102.3	21.2	228.2	DN25	DN32
NEDX 5003 155 7D	31.81	23.29	153.5	31.8	314	DN32	DN40
NEDX 6301 82 7D	16.96	13.01	81.7	16.9	207.3	DN25	DN32
*NEDX 6301 103 7D	21.27	15.21	108.9	22.6	237.2	DN25	DN32
NEDX 6302 165 7D	35.26	25.32	163.6	33.9	361.6	DN32	DN40
*NEDX 6302 206 7D	42.87	30.85	218.1	45.2	415.9	DN40	DN50
NEDX 6303 247 7D	52.89	36.83	245.5	50.9	504.6	DN40	DN50
*NEDX 6303 309 7D	61.58	39.51	327.3	67.9	577.7	DN50	DN65

Modelo / Model	Ventilador con Motor Axial / Axial Fans							Desescarche Eléctrico Electric Defrost		
	Diámetro / Diameter (ø mm)	Nº	Voltaje / Voltage (V, 50Hz)	Potencia / Power (W)	Intensidad / Current (A)	Flujo de aire / Air Flow (m3/h)	Tiro / Air Throw (m)	Aletas / Coil (W)	Desagüe / Drain Pan (W)	Total / Total (W)
NEDX 4001 31 7D	400	1	1 ~ 230	177	0.3	3124	2 × 6	4 × 700	4 × 700	5600
NEDX 4002 62 7D	400	2	1 ~ 230	354	0.6	6237	2 × 7	4 × 1510	4 × 1510	12080
NEDX 4003 93 7D	400	3	1 ~ 230	531	0.9	9352	2 × 8	4 × 1700	4 × 1700	13600
NEDX 4501 41 7D	450	1	3 ~ 400	350	1.1	4517	2 × 8	4 × 850	4 × 850	6800
NEDX 4502 82 7D	450	2	3 ~ 400	700	2.2	9019	2 × 9	4 × 1800	4 × 1800	14400
NEDX 4503 123 7D	450	3	3 ~ 400	1050	3.3	13538	2 × 11	4 × 2740	4 × 2740	21920
NEDX 5001 51 7D	500	1	3 ~ 400	577	1.4	7056	2 × 9	4 × 1280	4 × 1280	10240
NEDX 5002 103 7D	500	2	3 ~ 400	1154	2.8	14115	2 × 11	4 × 2320	4 × 2320	18560
NEDX 5003 155 7D	500	3	3 ~ 400	1731	4.1	21175	2 × 13	4 × 3200	4 × 3200	25600
NEDX 6301 82 7D	630	1	3 ~ 400	1118	2.3	10371	2 × 10	6 × 1510	4 × 1510	15100
*NEDX 6301 103 7D	630	1	3 ~ 400	1118	2.3	11605	2 × 9	8 × 1510	4 × 1510	18120
NEDX 6302 165 7D	630	2	3 ~ 400	2236	4.5	20724	2 × 12	6 × 2740	4 × 2740	27400
*NEDX 6302 206 7D	630	2	3 ~ 400	2236	4.5	23218	2 × 11	8 × 2740	4 × 2740	32880
NEDX 6303 247 7D	630	3	3 ~ 400	3354	6.8	31078	2 × 14	6 × 3800	4 × 3800	38000
*NEDX 6303 309 7D	630	3	3 ~ 400	3354	6.8	34806	2 × 13	8 × 3800	4 × 3800	45600

FIN SPACING 10 mm, with electrical defrost. Rt>=-35°C

SEPARACIÓN ALETAS 10 mm, con desescarche eléctrico. Rt>=-35°C

Modelo / Model	Capacidad / Capacity R717 (kw)		Superficie / Surface (m ²)	Volumen interno / Tube Volume (dm ³)	Peso Neto / N.W. (kg)	Conexión / Connection (ømm)	
	te= -8°C	te= -25°C				Entrada / Inlet	Salida / Outlet
	DT1=8K	DT1=7K					
NEDX 4001 22 10D	3.96	3.19	22	6.3	94.9	DN15	DN20
NEDX 4002 43 10D	9.25	6.58	44.1	12.7	155.3	DN20	DN25
NEDX 4003 65 10D	13.37	8.57	66.3	19.1	210.8	DN25	DN32
NEDX 4501 29 10D	6.11	4.7	29.4	8.5	107.6	DN15	DN20
NEDX 4502 58 10D	12.73	8.41	58.9	17	180.7	DN25	DN32
NEDX 4503 86 10D	19.59	14.01	88.4	25.5	247.7	DN25	DN32
NEDX 5001 36 10D	8.93	6.59	36.8	10.6	128.4	DN20	DN25
NEDX 5002 72 10D	17.97	13.33	73.6	21.2	222.5	DN25	DN32
NEDX 5003 108 10D	27.02	20.08	110.5	31.8	305.4	DN32	DN40
NEDX 6301 58 10D	14.63	11.35	58.8	16.9	202.7	DN25	DN32
*NEDX 6301 72 10D	18.52	13.46	78.4	22.6	231.1	DN25	DN32
NEDX 6302 115 10D	30.76	22.49	117.8	33.9	352.5	DN32	DN40
*NEDX 6302 144 10D	37.25	27.23	157	45.2	403.7	DN40	DN50
NEDX 6303 173 10D	46.43	33.01	176.7	50.9	490.8	DN40	DN50
*NEDX 6303 216 10D	54.92	36.17	235.6	67.9	559.2	DN50	DN65

Modelo / Model	Ventilador con Motor Axial / Axial Fans							Desescarche Eléctrico Electric Defrost		
	Diámetro / Diameter (ø mm)	Nº	Voltaje / Voltage (V, 50Hz)	Potencia / Power (W)	Intensidad / Current (A)	Flujo de aire / Air Flow (m3/h)	Tiro / Air Throw (m)	Aletas / Coil (W)	Desagüe / Drain Pan (W)	Total / Total (W)
NEDX 4001 22 10D	400	1	1 ~ 230	177	0.3	3202	2 × 6	4 × 700	4 × 700	5600
NEDX 4002 43 10D	400	2	1 ~ 230	354	0.6	6393	2 × 7	4 × 1510	4 × 1510	12080
NEDX 4003 65 10D	400	3	1 ~ 230	531	0.9	9586	2 × 8	4 × 1700	4 × 1700	13600
NEDX 4501 29 10D	450	1	3 ~ 400	350	1.1	4697	2 × 8	4 × 850	4 × 850	6800
NEDX 4502 58 10D	450	2	3 ~ 400	700	2.2	9377	2 × 9	4 × 1800	4 × 1800	14400
NEDX 4503 86 10D	450	3	3 ~ 400	1050	3.3	14075	2 × 11	4 × 2740	4 × 2740	21920
NEDX 5001 36 10D	500	1	3 ~ 400	577	1.4	7302	2 × 8	4 × 1280	4 × 1280	10240
NEDX 5002 72 10D	500	2	3 ~ 400	1154	2.8	14607	2 × 10	4 × 2320	4 × 2320	18560
NEDX 5003 108 10D	500	3	3 ~ 400	1731	4.1	21911	2 × 12	4 × 3200	4 × 3200	25600
NEDX 6301 58 10D	630	1	3 ~ 400	1118	2.3	10894	2 × 11	6 × 1510	4 × 1510	15100
*NEDX 6301 72 10D	630	1	3 ~ 400	1118	2.3	12053	2 × 10	8 × 1510	4 × 1510	18120
NEDX 6302 115 10D	630	2	3 ~ 400	2236	4.5	21763	2 × 13	6 × 2740	4 × 2740	27400
*NEDX 6302 144 10D	630	2	3 ~ 400	2236	4.5	24115	2 × 12	8 × 2740	4 × 2740	32880
NEDX 6303 173 10D	630	3	3 ~ 400	3354	6.8	32634	2 × 15	6 × 3800	4 × 3800	38000
*NEDX 6303 216 10D	630	3	3 ~ 400	3354	6.8	36146	2 × 14	8 × 3800	4 × 3800	45600

FIN SPACING 4 mm, with electrical defrost. Rt>=0°C

SEPARACIÓN ALETAS 4 mm, con desescarche eléctrico. Rt>=0°C

Modelo / Model	Capacidad / Capacity R717 (kw)		Superficie / Surface (m ²)	Volumen interno / Tube Volume (dm ³)	Peso Neto / N.W. (kg)	Conexión / Connection (ømm)	
	te= 0°C	te= -8°C				Entrada / Inlet	Salida / Outlet
	DTI=10K	DTI=8K					
NEDX Plus 4001 23 4D	7.9	5.16	22.8	3.8	80.5	DN10	DN15
NEDX Plus 4001 34 4D	9.65	6.38	34.2	5.8	88.8	DN15	DN20
NEDX Plus 4002 46 4D	15.81	10.33	45.6	7.7	132.5	DN15	DN20
NEDX Plus 4002 68 4D	20.71	14.07	68.4	11.5	147.8	DN20	DN25
NEDX Plus 4003 68 4D	25.6	17.22	68.4	11.5	176.1	DN20	DN25
NEDX Plus 4003 103 4D	31.1	21.12	102.6	17.3	199.7	DN25	DN32
NEDX Plus 4004 91 4D	34.97	23.82	91.2	15.3	226.8	DN25	DN32
NEDX Plus 4004 137 4D	42.53	29.23	136.8	23	257.5	DN25	DN32
NEDX Plus 4501 30 4D	11.69	7.83	30.4	5.1	90.5	DN15	DN20
NEDX Plus 4501 46 4D	14.76	10.18	45.6	7.7	100.9	DN15	DN20
NEDX Plus 4502 61 4D	23.42	15.7	60.8	10.2	152.2	DN20	DN25
NEDX Plus 4502 91 4D	29.65	20.46	91.2	15.3	172.6	DN25	DN32
NEDX Plus 4503 91 4D	36.57	25	91.2	15.3	203.7	DN25	DN32
NEDX Plus 4503 137 4D	44.54	30.75	136.8	23	234.5	DN25	DN32
NEDX Plus 4504 122 4D	48.26	32.8	121.1	19.2	263.6	DN25	DN32
NEDX Plus 4504 182 4D	59.43	41.03	182.4	30.7	305.1	DN32	DN40
NEDX Plus 5001 57 4D	21.39	14.59	57	9.6	128.2	DN20	DN25
NEDX Plus 5001 76 4D	23.54	16.22	76	12.8	141.7	DN20	DN25
NEDX Plus 5002 114 4D	42.91	29.28	114	19.2	219.2	DN25	DN32
NEDX Plus 5002 152 4D	47.19	32.53	152	25.6	245.3	DN32	DN40
NEDX Plus 5003 171 4D	64.73	44.75	171	28.8	298.3	DN32	DN40
NEDX Plus 5003 228 4D	71.69	49.95	228	38.4	337	DN40	DN50
NEDX Plus 5004 228 4D	85.94	58.67	228	38.4	390.7	DN40	DN50
NEDX Plus 5004 304 4D	94.48	65.13	303.9	51.2	442.7	DN40	DN50
NEDX Plus 6301 103 4D	39.37	27.03	102.6	17.3	216.2	DN25	DN32
NEDX Plus 6301 137 4D	44.05	30.31	136.8	23	239.5	DN25	DN32
NEDX Plus 6302 205 4D	79.19	54.25	205.2	34.5	372.8	DN40	DN50
NEDX Plus 6302 274 4D	88.37	60.84	273.6	46	418.1	DN40	DN50
NEDX Plus 6303 308 4D	118.94	81.75	307.7	51.8	516.8	DN50	DN65
NEDX Plus 6303 410 4D	132.97	91.82	410.3	69.1	584.4	DN50	DN65
NEDX Plus 6304 410 4D	158.67	108.74	410.3	69.1	681.3	DN50	DN65
NEDX Plus 6304 547 4D	177.02	121.89	547.1	92.1	773.1	DN65	DN80
NEDX Plus 8001 160 4D	54.26	37.21	159.6	26.9	309.9	DN32	DN40
NEDX Plus 8001 213 4D	59.88	41.41	212.8	35.8	344.9	DN32	DN40
NEDX Plus 8002 319 4D	108.97	74.77	319.1	53.7	539.4	DN50	DN65
NEDX Plus 8002 426 4D	120.15	83.12	425.5	71.6	608.3	DN50	DN65
NEDX Plus 8003 479 4D	162	110.22	478.7	80.6	764	DN50	DN65
NEDX Plus 8003 638 4D	178.14	122.25	638.3	107.4	872.3	DN65	DN80

Modelo / Model	Ventilador con Motor Axial / Axial Fans							Desescarche Eléctrico Electric Defrost		
	Diámetro / Diameter (ø mm)	Nº	Voltaje / Voltage (V, 50Hz)	Potencia / Power (W)	Intensidad / Current (A)	Flujo de aire / Air Flow (m3/h)	Tiro / Air Throw (m)	Aletas / Coil (W)	Desagüe / Drain Pan (W)	Total / Total (W)
NEDX Plus 4001 23 4D	400	1	1 ~ 230	177	0.3	3098	2 × 5	4 × 750	2 × 750	4500
NEDX Plus 4001 34 4D	400	1	1 ~ 230	177	0.3	2853	2 × 5	4 × 750	4 × 750	6000
NEDX Plus 4002 46 4D	400	2	1 ~ 230	354	0.6	6195	2 × 6	4 × 1250	2 × 1250	7500
NEDX Plus 4002 68 4D	400	2	1 ~ 230	354	0.6	5700	2 × 6	4 × 1250	4 × 1250	10000
NEDX Plus 4003 68 4D	400	3	1 ~ 230	531	0.9	9282	2 × 8	4 × 1700	2 × 1700	10200
NEDX Plus 4003 103 4D	400	3	1 ~ 230	531	0.9	8549	2 × 7	4 × 1700	4 × 1700	13600
NEDX Plus 4004 91 4D	400	4	1 ~ 230	708	1.2	12371	2 × 9	4 × 2740	2 × 2740	16440
NEDX Plus 4004 137 4D	400	4	1 ~ 230	708	1.2	11393	2 × 8	4 × 2740	4 × 2740	21920
NEDX Plus 4501 30 4D	450	1	3 ~ 400	350	1.1	4464	2 × 7	4 × 730	2 × 730	4380
NEDX Plus 4501 46 4D	450	1	3 ~ 400	350	1.1	4081	2 × 6	4 × 730	4 × 730	5840
NEDX Plus 4502 61 4D	450	2	3 ~ 400	700	2.2	8928	2 × 8	4 × 1800	2 × 1800	10800
NEDX Plus 4502 91 4D	450	2	3 ~ 400	700	2.2	8162	2 × 7	4 × 1800	4 × 1800	14400
NEDX Plus 4503 91 4D	450	3	3 ~ 400	1050	3.3	13380	2 × 9	4 × 2740	2 × 2740	16440
NEDX Plus 4503 137 4D	450	3	3 ~ 400	1050	3.3	12243	2 × 9	4 × 2740	4 × 2740	21920
NEDX Plus 4504 122 4D	450	4	3 ~ 400	1400	4.4	17845	2 × 11	4 × 3390	2 × 3390	20340
NEDX Plus 4504 182 4D	450	4	3 ~ 400	1400	4.4	16323	2 × 10	4 × 3390	4 × 3390	27120
NEDX Plus 5001 57 4D	500	1	3 ~ 400	577	1.4	6369	2 × 8	4 × 1280	4 × 1280	10240
NEDX Plus 5001 76 4D	500	1	3 ~ 400	577	1.4	5906	2 × 8	6 × 1280	4 × 1280	12800
NEDX Plus 5002 114 4D	500	2	3 ~ 400	1154	2.8	12738	2 × 10	4 × 2320	4 × 2320	18560
NEDX Plus 5002 152 4D	500	2	3 ~ 400	1154	2.8	11811	2 × 9	6 × 2320	4 × 2320	23200
NEDX Plus 5003 171 4D	500	3	3 ~ 400	1731	4.1	19095	2 × 12	4 × 3200	4 × 3200	25600
NEDX Plus 5003 228 4D	500	3	3 ~ 400	1731	4.1	17708	2 × 11	6 × 3200	4 × 3200	32000
NEDX Plus 5004 228 4D	500	4	3 ~ 400	2308	5.5	25475	2 × 14	4 × 4260	4 × 4260	34080
NEDX Plus 5004 304 4D	500	4	3 ~ 400	2308	5.5	23621	2 × 13	6 × 4260	4 × 4260	42600
NEDX Plus 6301 103 4D	630	1	3 ~ 400	1118	2.3	11650	2 × 10	6 × 1250	4 × 1250	12500
NEDX Plus 6301 137 4D	630	1	3 ~ 400	1118	2.3	10920	2 × 10	8 × 1250	4 × 1250	15000
NEDX Plus 6302 205 4D	630	2	3 ~ 400	2236	4.5	23302	2 × 13	6 × 2740	4 × 2740	27400
NEDX Plus 6302 274 4D	630	2	3 ~ 400	2236	4.5	21840	2 × 12	8 × 2740	4 × 2740	32880
NEDX Plus 6303 308 4D	630	3	3 ~ 400	3354	6.8	34948	2 × 15	6 × 3800	4 × 3800	38000
NEDX Plus 6303 410 4D	630	3	3 ~ 400	3354	6.8	32757	2 × 14	8 × 3800	4 × 3800	45600
NEDX Plus 6304 410 4D	630	4	3 ~ 400	4472	9	46604	2 × 18	6 × 5060	4 × 5060	50600
NEDX Plus 6304 547 4D	630	4	3 ~ 400	4472	9	43680	2 × 17	8 × 5060	4 × 5060	60720
NEDX Plus 8001 160 4D	800	1	3 ~ 400	1369	3.4	15026	2 × 11	8 × 1700	4 × 1700	20400
NEDX Plus 8001 213 4D	800	1	3 ~ 400	1369	3.4	14129	2 × 10	10 × 1700	4 × 1700	23800
NEDX Plus 8002 319 4D	800	2	3 ~ 400	2738	6.7	30051	2 × 13	8 × 2810	4 × 2810	33720
NEDX Plus 8002 426 4D	800	2	3 ~ 400	2738	6.7	28257	2 × 12	10 × 2810	4 × 2810	39340
NEDX Plus 8003 479 4D	800	3	3 ~ 400	4107	10.1	45089	2 × 16	8 × 4420	4 × 4420	53040
NEDX Plus 8003 638 4D	800	3	3 ~ 400	4107	10.1	42395	2 × 15	10 × 4420	4 × 4420	61880

FIN SPACING 6 mm, with electrical defrost. Rt>=-18°C

SEPARACIÓN ALETAS 6 mm, con desescarche eléctrico. Rt>=-18°C

Modelo / Model	Capacidad / Capacity R717 (kw)		Superficie / Surface (m ²)	Volumen interno / Tube Volume (dm ³)	Peso Neto / N.W. (kg)	Conexión / Connection (ømm)	
	te= -8°C	te= -25°C				Entrada / Inlet	Salida / Outlet
	DT1=8K	DT1=7K					
NEDX Plus 4001 16 6D	4.13	3.22	15.6	3.6	79.7	DN10	DN15
NEDX Plus 4001 24 6D	5.39	4.2	23.4	5.4	87.5	DN15	DN20
NEDX Plus 4002 31 6D	8.1	6.36	31	6.7	130.8	DN15	DN20
NEDX Plus 4002 47 6D	12.02	8.93	46.7	10.6	145.2	DN20	DN25
NEDX Plus 4003 47 6D	13.77	10.25	46.5	10.1	173.5	DN20	DN25
NEDX Plus 4003 71 6D	18.33	13.56	70.6	17.3	195.8	DN25	DN32
NEDX Plus 4004 63 6D	19.7	14.16	62.7	15.3	223.3	DN25	DN32
NEDX Plus 4004 94 6D	25.54	18.58	94.1	23	252.4	DN25	DN32
NEDX Plus 4501 21 6D	6.47	4.86	20.9	5.1	89.3	DN15	DN20
NEDX Plus 4501 31 6D	8.89	6.42	31.4	7.7	99.2	DN15	DN20
NEDX Plus 4502 42 6D	12.96	9.75	41.8	10.2	149.9	DN20	DN25
NEDX Plus 4502 63 6D	17.85	12.97	62.7	15.3	169.1	DN25	DN32
NEDX Plus 4503 63 6D	20.84	15	62.7	15.3	200.2	DN25	DN32
NEDX Plus 4503 94 6D	26.82	19.52	94.1	23	229.4	DN25	DN32
NEDX Plus 4504 84 6D	27.15	19.8	83.1	19.2	259	DN25	DN32
NEDX Plus 4504 125 6D	35.78	26.05	125.4	30.7	298.1	DN32	DN40
NEDX Plus 5001 39 6D	12.59	9.22	39.2	9.6	125.9	DN20	DN25
NEDX Plus 5001 52 6D	14.55	10.71	52.3	12.8	138.8	DN20	DN25
NEDX Plus 5002 78 6D	25.25	18.52	78.4	19.2	214.9	DN25	DN32
NEDX Plus 5002 105 6D	29.17	21.52	104.5	25.6	239.5	DN32	DN40
NEDX Plus 5003 118 6D	39.14	27.55	117.6	28.8	291.8	DN32	DN40
NEDX Plus 5003 157 6D	45.34	32.43	156.8	38.4	328.4	DN40	DN50
NEDX Plus 5004 157 6D	50.57	37.12	156.8	38.4	382	DN40	DN50
NEDX Plus 5004 209 6D	58.4	43.14	209.1	51.2	431.2	DN40	DN50
NEDX Plus 6301 71 6D	23.44	16.55	70.6	17.3	212.3	DN25	DN32
NEDX Plus 6301 94 6D	27.16	19.7	94.1	23	234.4	DN25	DN32
NEDX Plus 6302 141 6D	46.77	33.63	141.1	34.5	365	DN40	DN50
NEDX Plus 6302 188 6D	54.47	39.65	188.2	46	407.7	DN40	DN50
NEDX Plus 6303 212 6D	70.77	50.34	211.7	51.8	505.1	DN50	DN65
NEDX Plus 6303 282 6D	82.5	59.53	282.2	69.1	568.9	DN50	DN65
NEDX Plus 6304 282 6D	93.7	67.52	282.2	69.1	665.8	DN50	DN65
NEDX Plus 6304 376 6D	109.11	79.57	376.3	92.1	752.4	DN65	DN80
NEDX Plus 8001 110 6D	32.28	22.93	109.8	26.9	303.9	DN32	DN40
NEDX Plus 8001 146 6D	37.53	26.98	146.3	35.8	336.8	DN32	DN40
NEDX Plus 8002 220 6D	64.8	46.22	219.5	53.7	527.2	DN50	DN65
NEDX Plus 8002 293 6D	75.28	54.33	292.7	71.6	592	DN50	DN65
NEDX Plus 8003 329 6D	94.61	69.01	329.3	80.6	745.9	DN50	DN65
NEDX Plus 8003 439 6D	109.81	80.69	439	107.4	848.1	DN65	DN80

Modelo / Model	Ventilador con Motor Axial / Axial Fans							Desescarche Eléctrico Electric Defrost		
	Diámetro / Diameter (ø mm)	Nº	Voltaje / Voltage (V, 50Hz)	Potencia / Power (W)	Intensidad / Current (A)	Flujo de aire / Air Flow (m3/h)	Tiro / Air Throw (m)	Aletas / Coil (W)	Desagüe / Drain Pan (W)	Total / Total (W)
NEDX Plus 4001 16 6D	400	1	1 ~ 230	177	0.3	3189	2 × 6	4 × 750	2 × 750	4500
NEDX Plus 4001 24 6D	400	1	1 ~ 230	177	0.3	2998	2 × 5	4 × 750	4 × 750	6000
NEDX Plus 4002 31 6D	400	2	1 ~ 230	354	0.6	6379	2 × 7	4 × 1250	2 × 1250	7500
NEDX Plus 4002 47 6D	400	2	1 ~ 230	354	0.6	5988	2 × 6	4 × 1250	4 × 1250	10000
NEDX Plus 4003 47 6D	400	3	1 ~ 230	531	0.9	9556	2 × 8	4 × 1700	2 × 1700	10200
NEDX Plus 4003 71 6D	400	3	1 ~ 230	531	0.9	8980	2 × 7	4 × 1700	4 × 1700	13600
NEDX Plus 4004 63 6D	400	4	1 ~ 230	708	1.2	12734	2 × 9	4 × 2740	2 × 2740	16440
NEDX Plus 4004 94 6D	400	4	1 ~ 230	708	1.2	11966	2 × 9	4 × 2740	4 × 2740	21920
NEDX Plus 4501 21 6D	450	1	3 ~ 400	350	1.1	4664	2 × 7	4 × 730	2 × 730	4380
NEDX Plus 4501 31 6D	450	1	3 ~ 400	350	1.1	4288	2 × 6	4 × 730	4 × 730	5840
NEDX Plus 4502 42 6D	450	2	3 ~ 400	700	2.2	9328	2 × 8	4 × 1800	2 × 1800	10800
NEDX Plus 4502 63 6D	450	2	3 ~ 400	700	2.2	8576	2 × 8	4 × 1800	4 × 1800	14400
NEDX Plus 4503 63 6D	450	3	3 ~ 400	1050	3.3	13976	2 × 10	4 × 2740	2 × 2740	16440
NEDX Plus 4503 94 6D	450	3	3 ~ 400	1050	3.3	12864	2 × 9	4 × 2740	4 × 2740	21920
NEDX Plus 4504 84 6D	450	4	3 ~ 400	1400	4.4	18641	2 × 12	4 × 3390	2 × 3390	20340
NEDX Plus 4504 125 6D	450	4	3 ~ 400	1400	4.4	17152	2 × 11	4 × 3390	4 × 3390	27120
NEDX Plus 5001 39 6D	500	1	3 ~ 400	577	1.4	6695	2 × 9	4 × 1280	4 × 1280	10240
NEDX Plus 5001 52 6D	500	1	3 ~ 400	577	1.4	6250	2 × 8	6 × 1280	4 × 1280	12800
NEDX Plus 5002 78 6D	500	2	3 ~ 400	1154	2.8	13390	2 × 10	4 × 2320	4 × 2320	18560
NEDX Plus 5002 105 6D	500	2	3 ~ 400	1154	2.8	12500	2 × 10	6 × 2320	4 × 2320	23200
NEDX Plus 5003 118 6D	500	3	3 ~ 400	1731	4.1	20071	2 × 12	4 × 3200	4 × 3200	25600
NEDX Plus 5003 157 6D	500	3	3 ~ 400	1731	4.1	18739	2 × 12	6 × 3200	4 × 3200	32000
NEDX Plus 5004 157 6D	500	4	3 ~ 400	2308	5.5	26780	2 × 15	4 × 4260	4 × 4260	34080
NEDX Plus 5004 209 6D	500	4	3 ~ 400	2308	5.5	25000	2 × 14	6 × 4260	4 × 4260	42600
NEDX Plus 6301 71 6D	630	1	3 ~ 400	1118	2.3	12149	2 × 11	6 × 1250	4 × 1250	12500
NEDX Plus 6301 94 6D	630	1	3 ~ 400	1118	2.3	11467	2 × 10	8 × 1250	4 × 1250	15000
NEDX Plus 6302 141 6D	630	2	3 ~ 400	2236	4.5	24301	2 × 13	6 × 2740	4 × 2740	27400
NEDX Plus 6302 188 6D	630	2	3 ~ 400	2236	4.5	22934	2 × 12	8 × 2740	4 × 2740	32880
NEDX Plus 6303 212 6D	630	3	3 ~ 400	3354	6.8	36446	2 × 16	6 × 3800	4 × 3800	38000
NEDX Plus 6303 282 6D	630	3	3 ~ 400	3354	6.8	34396	2 × 15	8 × 3800	4 × 3800	45600
NEDX Plus 6304 282 6D	630	4	3 ~ 400	4472	9	48601	2 × 19	6 × 5060	4 × 5060	50600
NEDX Plus 6304 376 6D	630	4	3 ~ 400	4472	9	45867	2 × 18	8 × 5060	4 × 5060	60720
NEDX Plus 8001 110 6D	800	1	3 ~ 400	1369	3.4	15549	2 × 11	8 × 1700	4 × 1700	20400
NEDX Plus 8001 146 6D	800	1	3 ~ 400	1369	3.4	14830	2 × 11	10 × 1700	4 × 1700	23800
NEDX Plus 8002 220 6D	800	2	3 ~ 400	2738	6.7	31097	2 × 14	8 × 2810	4 × 2810	33720
NEDX Plus 8002 293 6D	800	2	3 ~ 400	2738	6.7	29659	2 × 13	10 × 2810	4 × 2810	39340
NEDX Plus 8003 329 6D	800	3	3 ~ 400	4107	10.1	46660	2 × 16	8 × 4420	4 × 4420	53040
NEDX Plus 8003 439 6D	800	3	3 ~ 400	4107	10.1	44500	2 × 16	10 × 4420	4 × 4420	61880

FIN SPACING 9 mm, with electrical defrost. Rt>=-35°C

SEPARACIÓN ALETAS 9 mm, con desescarche eléctrico. Rt>=-35°C

Modelo / Model	Capacidad / Capacity R717 (kw)		Superficie / Surface (m ²)	Volumen interno / Tube Volume (dm ³)	Peso Neto / N.W. (kg)	Conexión / Connection (ømm)	
	te= -8°C	te= -25°C				Entrada / Inlet	Salida / Outlet
	DT1=8K	DT1=7K					
NEDX Plus 4001 11 9D	3.32	2.57	10.9	3.8	78.5	DN10	DN15
NEDX Plus 4001 16 9D	4.51	3.49	16.4	5.8	85.9	DN15	DN20
NEDX Plus 4002 22 9D	6.64	5.15	21.9	7.7	128.6	DN15	DN20
NEDX Plus 4002 33 9D	10.11	7.47	32.8	11.5	141.9	DN20	DN25
NEDX Plus 4003 33 9D	11.21	8.28	32.8	11.5	170.2	DN20	DN25
NEDX Plus 4003 49 9D	15.18	11.22	49.2	17.3	191	DN25	DN32
NEDX Plus 4004 44 9D	15.71	11.38	43.7	15.3	219	DN25	DN32
NEDX Plus 4004 66 9D	21.26	15.49	65.6	23	245.8	DN25	DN32
NEDX Plus 4501 15 9D	5.14	3.85	14.6	5.1	87.8	DN15	DN20
NEDX Plus 4501 22 9D	7.43	5.41	21.9	7.7	97	DN15	DN20
NEDX Plus 4502 29 9D	10.3	7.73	29.2	10.2	147	DN20	DN25
NEDX Plus 4502 44 9D	14.91	10.89	43.7	15.3	164.8	DN25	DN32
NEDX Plus 4503 44 9D	16.69	12.08	43.7	15.3	195.9	DN25	DN32
NEDX Plus 4503 66 9D	22.38	16.37	65.6	23	222.8	DN25	DN32
NEDX Plus 4504 58 9D	21.61	15.76	57.8	19.2	253.3	DN25	DN32
NEDX Plus 4504 88 9D	29.86	21.86	87.5	30.7	289.5	DN32	DN40
NEDX Plus 5001 27 9D	10.43	7.66	27.3	9.6	123.3	DN20	DN25
NEDX Plus 5001 37 9D	12.48	9.18	36.5	12.8	135.2	DN20	DN25
NEDX Plus 5002 55 9D	20.9	15.37	54.7	19.2	209.5	DN25	DN32
NEDX Plus 5002 73 9D	25.01	18.43	72.9	25.6	232.3	DN32	DN40
NEDX Plus 5003 82 9D	32.78	23.4	82	28.8	283.7	DN32	DN40
NEDX Plus 5003 109 9D	39.28	28.33	109.4	38.4	317.6	DN40	DN50
NEDX Plus 5004 109 9D	41.84	30.79	109.4	38.4	371.3	DN40	DN50
NEDX Plus 5004 146 9D	50.06	36.94	145.8	51.2	416.8	DN40	DN50
NEDX Plus 6301 49 9D	19.41	13.86	49.2	17.3	207.4	DN25	DN32
NEDX Plus 6301 66 9D	23.25	16.93	65.6	23	227.8	DN25	DN32
NEDX Plus 6302 98 9D	38.53	27.86	98.4	34.5	355.2	DN40	DN50
NEDX Plus 6302 131 9D	46.61	34.03	131.2	46	394.7	DN40	DN50
NEDX Plus 6303 148 9D	58.49	42.01	147.6	51.8	490.6	DN50	DN65
NEDX Plus 6303 197 9D	70.8	51.36	196.8	69.1	549.5	DN50	DN65
NEDX Plus 6304 197 9D	77.13	55.89	196.8	69.1	646.3	DN50	DN65
NEDX Plus 6304 263 9D	93.32	68.22	262.5	92.1	726.5	DN65	DN80
NEDX Plus 8001 77 9D	26.83	19.25	76.6	26.9	296.3	DN32	DN40
NEDX Plus 8001 102 9D	32.29	23.35	102.1	35.8	326.7	DN32	DN40
NEDX Plus 8002 153 9D	53.81	38.74	153.1	53.7	512.2	DN50	DN65
NEDX Plus 8002 204 9D	64.72	46.93	204.1	71.6	572	DN50	DN65
NEDX Plus 8003 230 9D	77.97	56.96	229.7	80.6	723.2	DN50	DN65
NEDX Plus 8003 306 9D	93.77	68.82	306.2	107.4	817.8	DN65	DN80

Modelo / Model	Ventilador con Motor Axial / Axial Fans							Desescarche Eléctrico Electric Defrost		
	Diámetro / Diameter (ø mm)	Nº	Voltaje / Voltage (V, 50Hz)	Potencia / Power (W)	Intensidad / Current (A)	Flujo de aire / Air Flow (m3/h)	Tiro / Air Throw (m)	Aletas / Coil (W)	Desagüe / Drain Pan (W)	Total / Total (W)
NEDX Plus 4001 11 9D	400	1	1 ~ 230	177	0.3	3269	2 × 6	4 × 750	2 × 750	4500
NEDX Plus 4001 16 9D	400	1	1 ~ 230	177	0.3	3107	2 × 5	4 × 750	4 × 750	6000
NEDX Plus 4002 22 9D	400	2	1 ~ 230	354	0.6	6538	2 × 7	4 × 1250	2 × 1250	7500
NEDX Plus 4002 33 9D	400	2	1 ~ 230	354	0.6	6207	2 × 6	4 × 1250	4 × 1250	10000
NEDX Plus 4003 33 9D	400	3	1 ~ 230	531	0.9	9795	2 × 8	4 × 1700	2 × 1700	10200
NEDX Plus 4003 49 9D	400	3	1 ~ 230	531	0.9	9309	2 × 8	4 × 1700	4 × 1700	13600
NEDX Plus 4004 44 9D	400	4	1 ~ 230	708	1.2	13055	2 × 10	4 × 2740	2 × 2740	16440
NEDX Plus 4004 66 9D	400	4	1 ~ 230	708	1.2	12407	2 × 9	4 × 2740	4 × 2740	21920
NEDX Plus 4501 15 9D	450	1	3 ~ 400	350	1.1	4817	2 × 7	4 × 730	2 × 730	4380
NEDX Plus 4501 22 9D	450	1	3 ~ 400	350	1.1	4477	2 × 7	4 × 730	4 × 730	5840
NEDX Plus 4502 29 9D	450	2	3 ~ 400	700	2.2	9634	2 × 8	4 × 1800	2 × 1800	10800
NEDX Plus 4502 44 9D	450	2	3 ~ 400	700	2.2	8954	2 × 8	4 × 1800	4 × 1800	14400
NEDX Plus 4503 44 9D	450	3	3 ~ 400	1050	3.3	14439	2 × 10	4 × 2740	2 × 2740	16440
NEDX Plus 4503 66 9D	450	3	3 ~ 400	1050	3.3	13431	2 × 9	4 × 2740	4 × 2740	21920
NEDX Plus 4504 58 9D	450	4	3 ~ 400	1400	4.4	19257	2 × 12	4 × 3390	2 × 3390	20340
NEDX Plus 4504 88 9D	450	4	3 ~ 400	1400	4.4	17907	2 × 11	4 × 3390	4 × 3390	27120
NEDX Plus 5001 27 9D	500	1	3 ~ 400	577	1.4	7000	2 × 9	4 × 1280	4 × 1280	10240
NEDX Plus 5001 37 9D	500	1	3 ~ 400	577	1.4	6582	2 × 9	6 × 1280	4 × 1280	12800
NEDX Plus 5002 55 9D	500	2	3 ~ 400	1154	2.8	14000	2 × 11	4 × 2320	4 × 2320	18560
NEDX Plus 5002 73 9D	500	2	3 ~ 400	1154	2.8	13164	2 × 10	6 × 2320	4 × 2320	23200
NEDX Plus 5003 82 9D	500	3	3 ~ 400	1731	4.1	20983	2 × 13	4 × 3200	4 × 3200	25600
NEDX Plus 5003 109 9D	500	3	3 ~ 400	1731	4.1	19732	2 × 12	6 × 3200	4 × 3200	32000
NEDX Plus 5004 109 9D	500	4	3 ~ 400	2308	5.5	27999	2 × 15	4 × 4260	4 × 4260	34080
NEDX Plus 5004 146 9D	500	4	3 ~ 400	2308	5.5	26328	2 × 15	6 × 4260	4 × 4260	42600
NEDX Plus 6301 49 9D	630	1	3 ~ 400	1118	2.3	12518	2 × 11	6 × 1250	4 × 1250	12500
NEDX Plus 6301 66 9D	630	1	3 ~ 400	1118	2.3	11978	2 × 11	8 × 1250	4 × 1250	15000
NEDX Plus 6302 98 9D	630	2	3 ~ 400	2236	4.5	25038	2 × 13	6 × 2740	4 × 2740	27400
NEDX Plus 6302 131 9D	630	2	3 ~ 400	2236	4.5	23955	2 × 13	8 × 2740	4 × 2740	32880
NEDX Plus 6303 148 9D	630	3	3 ~ 400	3354	6.8	37552	2 × 16	6 × 3800	4 × 3800	38000
NEDX Plus 6303 197 9D	630	3	3 ~ 400	3354	6.8	35926	2 × 15	8 × 3800	4 × 3800	45600
NEDX Plus 6304 197 9D	630	4	3 ~ 400	4472	9	50076	2 × 19	6 × 5060	4 × 5060	50600
NEDX Plus 6304 263 9D	630	4	3 ~ 400	4472	9	47908	2 × 18	8 × 5060	4 × 5060	60720
NEDX Plus 8001 77 9D	800	1	3 ~ 400	1369	3.4	16016	2 × 12	8 × 1700	4 × 1700	20400
NEDX Plus 8001 102 9D	800	1	3 ~ 400	1369	3.4	15371	2 × 11	10 × 1700	4 × 1700	23800
NEDX Plus 8002 153 9D	800	2	3 ~ 400	2738	6.7	32031	2 × 14	8 × 2810	4 × 2810	33720
NEDX Plus 8002 204 9D	800	2	3 ~ 400	2738	6.7	30741	2 × 13	10 × 2810	4 × 2810	39340
NEDX Plus 8003 230 9D	800	3	3 ~ 400	4107	10.1	48063	2 × 17	8 × 4420	4 × 4420	53040
NEDX Plus 8003 306 9D	800	3	3 ~ 400	4107	10.1	46126	2 × 16	10 × 4420	4 × 4420	61880

AVAILABLE OPTIONS FOR NEDX & NEDX PLUS SERIES

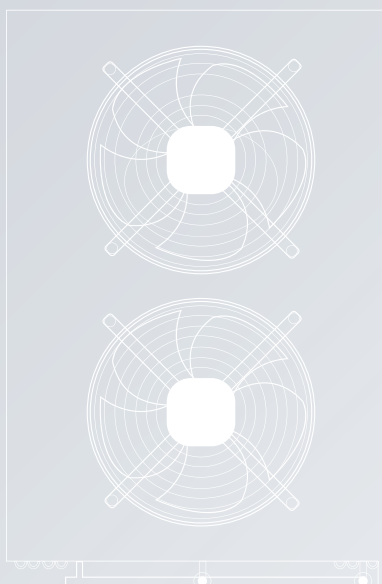
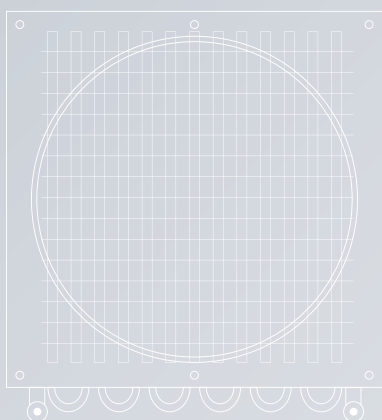
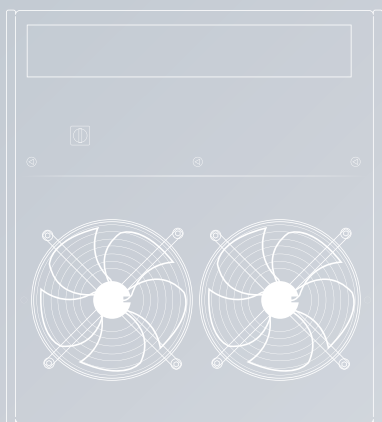
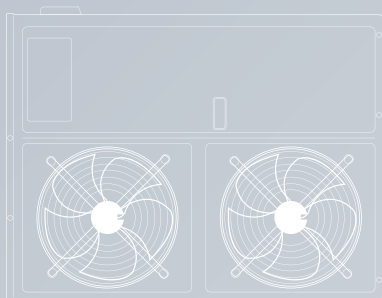

Defrost options:

- Air
- Electrical defrost
- Hot gas
- Water
- Hot gas for coil and electrical for tray
- Water and electrical



Tube material options:

- Stainless steel AISI SUS304



Coil protection options:

- Aluminium fins
- Fins with GOLDFIN anti-corrosion high resistance coating



Fan options:

- EC Fans



Casing options:

- White powder-coated painted aluminium
- Stainless steel AISI SUS304



Other options:

- Thermal protector for defrosting electrical heaters

OPCIONES DISPONIBLES PARA LA SERIE NEDX & NEDX PLUS



Opciones de desescarche:

- Aire
- Desescarche eléctrico
- Gas caliente
- Agua
- Aas caliente en serpentín y eléctrico en bandeja
- Agua y eléctrico



Tube material options:

- Acero inoxidable AISI SUS304



Coil protection options:

- Aleta de aluminio
- Aleta con tratamiento GOLDFIN con anticorrosión de alta resistencia



Fan options:

- Ventiladores EC



Casing options:

- Aluminio pintado al polvo blanco
- acero inoxidable AISI SUS304



Other options:

- Protector térmico para resistencias de desescarche



NEFX & NEXF Plus SERIES EVAPORATOR

EVAPORADORES SERIE NEXF & NEXF Plus

WALL TYPE EVAPORATORS EVAPORADORES TIPO MURAL

The NEFX & NEFX Plus range of wall type evaporators has been designed for use in the food refrigeration sector, both for rapid cooling and for freezing in tunnels.

The exchange coils used in the NEFX & NEFX Plus range are highly

The exchange coils used in the NEFX & NEFX Plus range are built with a geometry of recognized high efficiency, with special profile aluminum fins and $\varnothing 15$ mm high quality SS304 tubes, with high heat transfer coefficient. They are supplied clean and tested under a pressure of 30 bar.

01 White powder-coated aluminium casing with high resistance to corrosion and impacts.

02 In models with electric defrost, stainless steel electric heaters covered by aluminum tubes are used, located in the finned package to avoid steam problems and make easy replacement.

03 The electrical parts are connected to an earth terminal, inside a connection box with access holes equipped with cable glands with IP 65 protection.

04 For performance at work points other than those in this catalog, use the "Unit Selector Hybrid HISPANIA" software.



For special applications and additional information consult our Technical Department.

NEFX & NEFX Plus SERIES EVAPORATORS EVAPORADORES SERIE NEFX & NEFX Plus

La gama de evaporadores murales NEFX & NEFX Plus ha sido diseñada para su uso en el sector de la refrigeración alimentaria, tanto para enfriamiento rápido como para congelación en túneles.

Los baterías de intercambio utilizadas en la gama NEFX & NEFX Plus son

Los baterías de intercambio utilizadas en la gama NEFX & NEFX Plus están construidos con una geometría de reconocida alta eficiencia, con aletas de aluminio de perfil especial y tubos de SS304 de $\varnothing 15$ mm de alta calidad, con un alto coeficiente de transferencia de calor. Se suministran limpias y probadas a una presión de 30 bar.

01 La carcasa de aluminio pintado en blanco al polvo electrostático con alta resistencia a la corrosión y a los impactos.

02 En los modelos con desescarche eléctrico se usan resistencias en acero inoxidable cubiertas por tubos de aluminio, situados en el paquete aleteado para evitar problemas de vapor y facilitar la sustitución.

03 Las partes eléctricas están conectadas a un terminal de tierra, dentro de una caja de conexiones con orificios de acceso equipados con prensaestopas con grado de protección IP 65.

04 Para rendimientos en puntos de trabajo distintos a los de este catálogo utilizar el software "Unit Selector Hybrid HISPANIA".



Para aplicaciones especiales e informaciones adicionales consultar a nuestro Departamento Técnico.

NEFX 6302 211 7D S1 2 3

- Fin materials (blank: aluminum, 3: stainless steel, GF: golden fins) / Materiales de las aletas (en blanco: aluminio, 3: acero inoxidable, GF: aletas doradas)
- Casing materials (blank: aluminum, 2: stainless steel) / Materiales de la carcasa (en blanco: aluminio, 2: acero inoxidable)
- Tube materials (1: stainless steel) / Materiales del tubo (1: acero inoxidable)
- Defrost system (blank: air, D: electric, HG: hot gas, W: water, HGD: hot gas & electric, WD: water & electric) / Sistema de descongelación (en blanco: aire, D: eléctrico, HG: gas caliente, W: agua, HGD: gas caliente y eléctrico, WD: agua y electricidad)
- Fin spacing (mm) / Espacio entre aletas (mm)
- Surface (m²) / Superficie (m²)
- Fan number / Número de ventiladores
- Fan \varnothing (mm) / Ventilador \varnothing (mm)
- Series / Serie

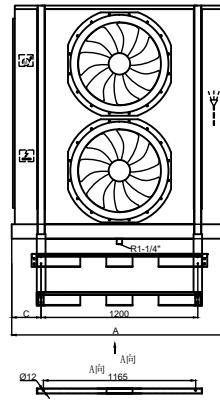
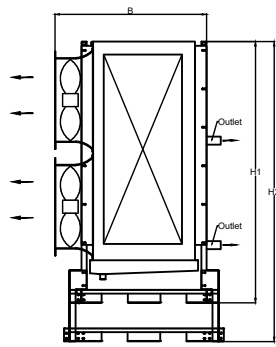

NEF 6302

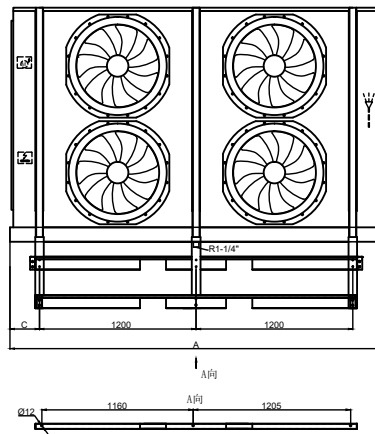

NEF 6304

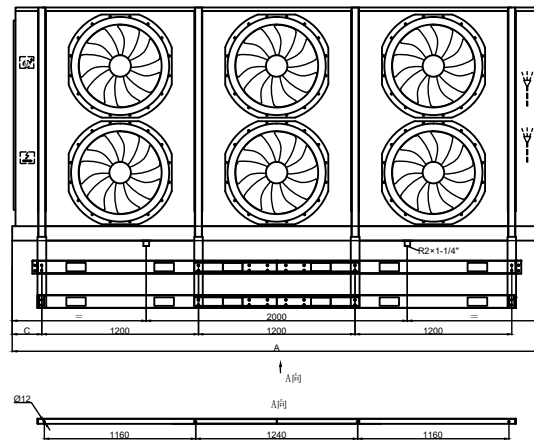

NEF 6306

Model / Model	Dimensions / dimensiones(mm)				
	A	B	C	H1	H2
NEFX 6302...(6 rows)	1715	1130	230	1965	2140
NEFX 6302...(8 rows)	1715	1130	230	1965	2140
NEFX 6302...(10 rows)	1715	1280	230	1965	2140
NEFX 6304...(6 rows)	2915	1130	230	1965	2140
NEFX 6304...(8 rows)	2915	1130	230	1965	2140
NEFX 6304...(10 rows)	2915	1280	230	1965	2140
NEFX 6306...(6 rows)	4115	1130	230	1965	2140
NEFX 6306...(8 rows)	4115	1130	230	1965	2140
NEFX 6306...(10 rows)	4165	1280	230	1965	2140

The number of rows refers to the number of tube rows in width in the heat exchanger. The number of rows can be found in the characteristics of each evaporator on the following pages.

El número de filas se refiere al número de filas de tubos en anchura en el intercambiador de calor. Se puede ver el número de filas en las características de cada evaporador en las páginas siguientes.

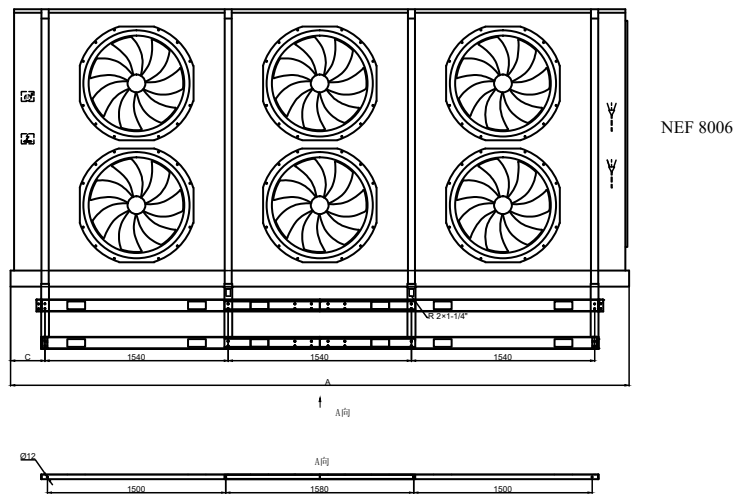
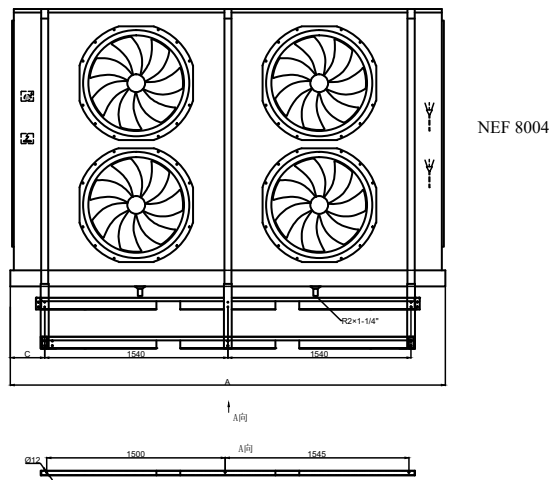
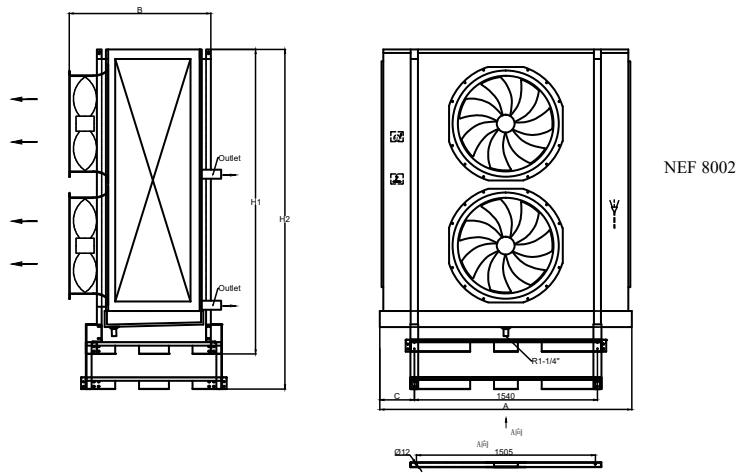

Model / Model	Dimensions / dimensiones(mm)				
	A	B	C	H1	H2
NEFX 8002...(6 rows)	2180	1240	295	2310	2605
NEFX 8002...(8 rows)	2180	1240	295	2310	2605
NEFX 8002...(10 rows)	2180	1340	295	2310	2605
NEFX 8004...(6 rows)	3720	1240	295	2310	2605
NEFX 8004...(8 rows)	3720	1240	295	2310	2605
NEFX 8004...(10 rows)	3720	1340	295	2310	2605
NEFX 8006...(6 rows)	5260	1240	295	2310	2605
NEFX 8006...(8 rows)	5260	1240	295	2310	2605
NEFX 8006...(10 rows)	5260	1340	295	2310	2605

The number of rows refers to the number of tube rows in width in the heat exchanger. The number of rows can be found in the characteristics of each evaporator on the following pages.

El número de filas se refiere al número de filas de tubos en anchura en el intercambiador de calor. Se puede ver el número de filas en las características de cada evaporador en las páginas siguientes.

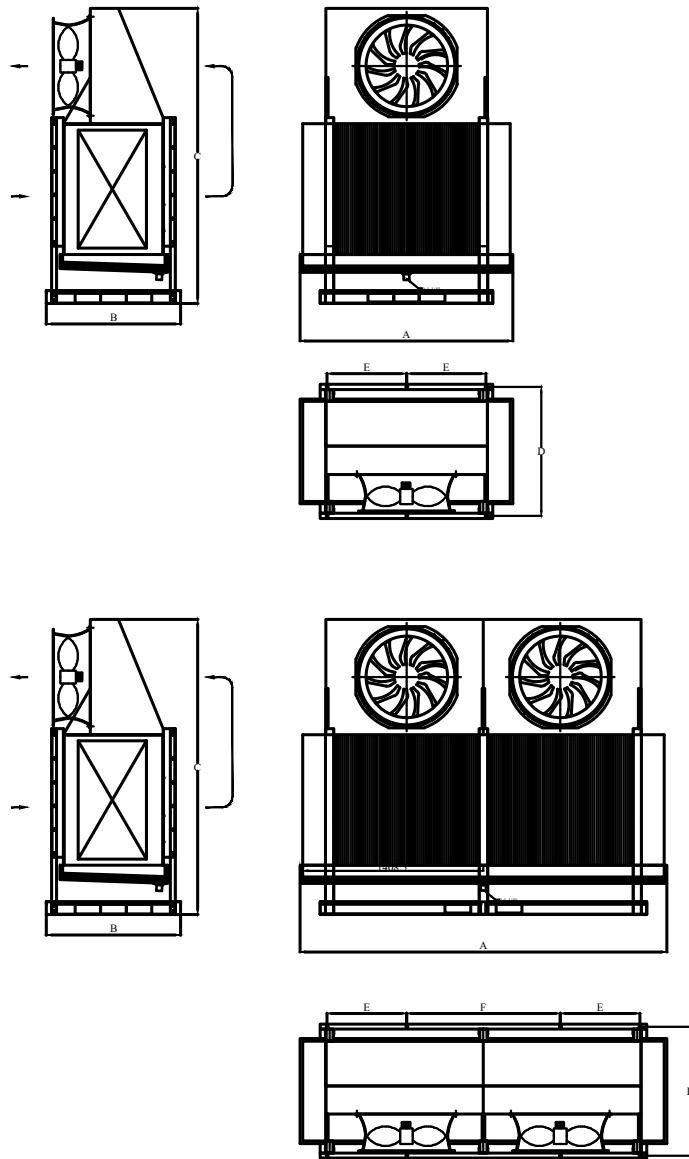

Model / Model	Dimensions / dimensiones(mm)					
	A	B	C	D	E	F
NEFX Plus 6301...(4 rows)	1660	1046	2300	1006	653	
NEFX Plus 6301...(6 rows)	1660	1046	2300	1006	653	
NEFX Plus 6301...(8 rows)	1660	1146	2300	1106	653	
NEFX Plus 6302...(4 rows)	2860	1046	2300	1006	653	1200
NEFX Plus 6302...(6 rows)	2860	1046	2300	1006	653	1200
NEFX Plus 6302...(8 rows)	2860	1146	2300	1106	653	1200

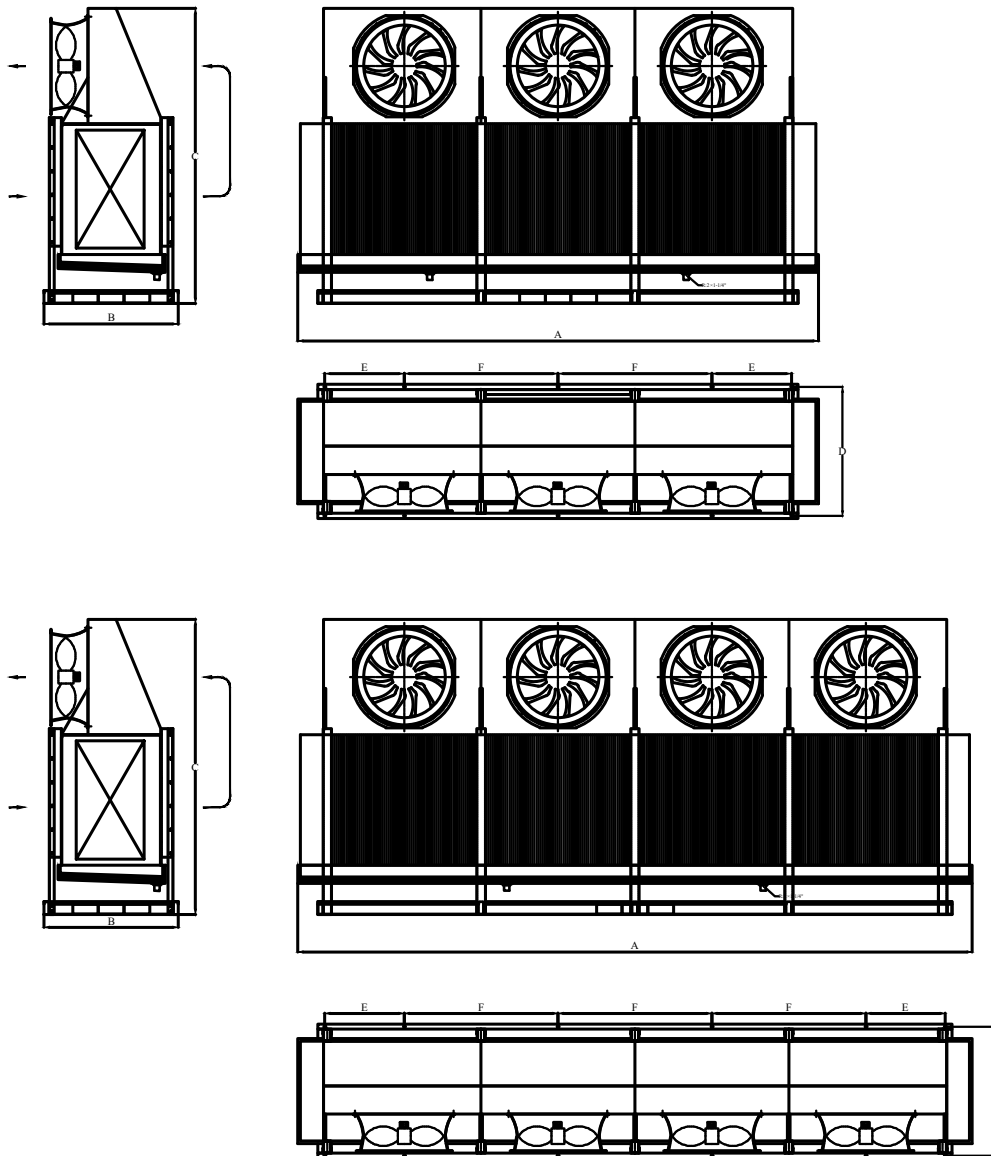

Model / Model	Dimensions / dimensiones(mm)					
	A	B	C	D	E	F
NEFX Plus 6303...(4 rows)	4060	1046	2300	1006	653	1200
NEFX Plus 6303...(6 rows)	4060	1046	2300	1006	653	1200
NEFX Plus 6303...(8 rows)	4060	1146	2300	1106	653	1200
NEFX Plus 6304...(4 rows)	5260	1046	2300	1006	653	1200
NEFX Plus 6304...(6 rows)	5260	1046	2300	1006	653	1200
NEFX Plus 6304...(8 rows)	5260	1146	2300	1106	653	1200

The number of rows refers to the number of tube rows in width in the heat exchanger. The number of rows can be found in the characteristics of each evaporator on the following pages.

El número de filas se refiere al número de filas de tubos en anchura en el intercambiador de calor. Se puede ver el número de filas en las características de cada evaporador en las páginas siguientes.

FIN SPACING 7 mm, with electrical defrost. Rt>=-20°C

SEPARACIÓN ALETAS 7 mm, con desescarche eléctrico. Rt>=-20°C

Modelo / Model	Capacidad / Capacity R717 (kw)		Superficie / Surface (m ²)	Volumen interno / Tube Volume (dm ³)	Filas de serpentin / Coil Rows	Peso Neto / N.W. (kg)	Conexión / Connection (ømm)	
	te= -8°C	te= -25°C					Entrada / Inlet	Salida / Outlet
	DTI=8K	DTI=7K						
NEFX 6302 170 7D	37.96	29.42	155.6	34.2	6	443.2	DN40	DN50
NEFX 6302 211 7D	48.07	34.48	207.5	45.6	8	483.1	DN40	DN50
NEFX 6302 259 7D	50.5	40.49	259.3	57	10	536.9	DN40	DN50
NEFX 6304 340 7D	78.09	60.4	319.4	70.2	6	785.7	DN50	DN65
NEFX 6304 424 7D	98.8	70.91	425.9	93.5	8	864.6	DN50	DN65
NEFX 6304 532 7D	103.89	82.96	532.3	116.9	10	962.9	DN65	DN80
NEFX 6306 511 7D	118.22	91.39	483.2	106.1	6	1122.5	DN65	DN80
NEFX 6306 637 7D	144.5	111.55	644.3	141.5	8	1235.7	DN65	DN80
NEFX 6306 805 7D	171.04	125.02	805.3	176.9	10	1375.4	2×DN50	2×DN65
NEFX 8002 264 7D	51.54	39.26	265.1	58.2	6	607.3	DN40	DN50
NEFX 8002 351 7D	61.76	47.16	353.5	77.6	8	676	DN50	DN65
NEFX 8002 421 7D	68.83	52.51	420.9	92.4	10	753.5	DN50	DN65
NEFX 8004 538 7D	105.14	79.99	541	118.8	6	1080.6	DN65	DN80
NEFX 8004 717 7D	126.07	96.02	721.4	158.4	8	1210.9	DN65	DN80
NEFX 8004 859 7D	140.46	106.96	858.8	188.6	10	1354.5	2×DN50	2×DN65
NEFX 8006 812 7D	162.7	118.7	816.9	179.4	6	1549.6	2×DN50	2×DN65
NEFX 8006 1083 7D	195.4	143.19	1089.2	239.2	8	1739.6	2×DN50	2×DN65
NEFX 8006 1297 7D	196.76	157.15	1296.7	284.8	10	1947.1	2×DN65	2×DN80

Modelo / Model	Ventilador con Motor Axial / Axial Fans							Desescarche Eléctrico Electric Defrost			
	Diámetro / Diameter (ø mm)	Nº	Voltaje / Voltage (V, 50Hz)	Potencia / Power (W)	Intensidad / Current (A)	Flujo de aire / Air Flow (m3/h)	Tiro / Air Throw (m)	Aletas / Coil (W)	Desagüe / Drain Pan (W)	Círculo del ventilador / Fan circle (W)	Total / Total (W)
NEFX 6302 170 7D	630	2	3 ~ 400	5400	10	33055	39	16 × 1510	2 × 1510	2 × 280	27740
NEFX 6302 211 7D	630	2	3 ~ 400	5400	10	30967	38	20 × 1510	2 × 1510	2 × 280	33780
NEFX 6302 259 7D	630	2	3 ~ 400	5400	10	29472	37	24 × 1510	2 × 1510	2 × 280	39820
NEFX 6304 340 7D	630	4	3 ~ 400	10800	20	66625	47	16 × 2740	2 × 2740	4 × 280	50440
NEFX 6304 424 7D	630	4	3 ~ 400	10800	20	62525	45	20 × 2740	2 × 2740	4 × 280	50440
NEFX 6304 532 7D	630	4	3 ~ 400	10800	20	59563	43	24 × 2740	2 × 2740	4 × 280	71800
NEFX 6306 511 7D	630	6	3 ~ 400	16200	30	100187	56	16 × 3800	2 × 3800	6 × 280	70080
NEFX 6306 637 7D	630	6	3 ~ 400	16200	30	94216	54	20 × 3800	2 × 3800	6 × 280	85280
NEFX 6306 805 7D	630	6	3 ~ 400	16200	30	89450	52	24 × 3800	2 × 3800	6 × 280	99360
NEFX 8002 264 7D	800	2	3 ~ 400	3200	7	35956	35	20 × 1800	2 × 1800	2 × 470	40540
NEFX 8002 351 7D	800	2	3 ~ 400	3200	7	33755	34	26 × 1800	2 × 1800	2 × 470	51340
NEFX 8002 421 7D	800	2	3 ~ 400	3200	7	31642	33	26 × 1800	2 × 1800	2 × 470	51340
NEFX 8004 538 7D	800	4	3 ~ 400	6400	14	72292	42	20 × 3200	2 × 3200	4 × 470	72280
NEFX 8004 717 7D	800	4	3 ~ 400	6400	14	68103	41	26 × 3200	2 × 3200	4 × 470	91480
NEFX 8004 859 7D	800	4	3 ~ 400	6400	14	63916	40	26 × 3200	2 × 3200	4 × 470	91480
NEFX 8006 812 7D	800	6	3 ~ 400	9600	21	108560	51	20 × 4800	2 × 4800	6 × 470	108420
NEFX 8006 1083 7D	800	6	3 ~ 400	9600	21	102368	49	26 × 4800	2 × 4800	6 × 470	137220
NEFX 8006 1297 7D	800	6	3 ~ 400	9600	21	96336	47	26 × 4800	2 × 4800	6 × 470	137220

FIN SPACING 10 mm, with electrical defrost. Rt>=-40°C

SEPARACIÓN ALETAS 10 mm, con desescarche eléctrico. Rt>=-40°C

Modelo / Model	Capacidad / Capacity R717 (kw)		Superficie / Surface (m ²)	Volumen interno / Tube Volume (dm ³)	Filas de serpentin / Coil Rows	Peso Neto / N.W. (kg)	Conexión / Connection (ømm)	
	te= -8°C	te= -25°C					Entrada / Inlet	Salida / Outlet
	DTI=8K	DTI=7K						
NEFX 6302 119 10D	31.88	25.01	112	34.2	6	434.1	DN40	DN50
NEFX 6302 148 10D	41.72	30.52	149.4	45.6	8	470.9	DN40	DN50
NEFX 6302 187 10D	43.71	35.37	186.7	57	10	521.7	DN40	DN50
NEFX 6304 238 10D	65.53	51.3	229.9	70.2	6	767.4	DN50	DN65
NEFX 6304 297 10D	85.69	62.66	306.6	93.5	8	840.2	DN50	DN65
NEFX 6304 383 10D	89.93	72.52	383.2	116.9	10	932.4	DN65	DN80
NEFX 6306 358 10D	99.19	77.59	347.8	106.1	6	1094.7	DN65	DN80
NEFX 6306 446 10D	123.74	96.51	463.8	141.5	8	1198.7	DN65	DN80
NEFX 6306 580 10D	150.06	111.59	579.7	176.9	10	1329.1	2×DN50	2×DN65
NEFX 8002 187 10D	43.4	33.44	190.9	58.2	6	592.4	DN40	DN50
NEFX 8002 249 10D	53.45	41.03	254.5	77.6	8	656.2	DN50	DN65
NEFX 8002 303 10D	61.07	47.01	303	92.4	10	728.6	DN50	DN65
NEFX 8004 381 10D	88.52	68.1	389.5	118.8	6	1050.8	DN65	DN80
NEFX 8004 509 10D	108.96	83.49	519.3	158.4	8	1171.3	DN65	DN80
NEFX 8004 618 10D	124.61	95.74	618.2	188.6	10	1304.9	2×DN50	2×DN65
NEFX 8006 576 10D	137.95	102.29	588.1	179.4	6	1504.9	2×DN50	2×DN65
NEFX 8006 767 10D	169.9	125.78	784.1	239.2	8	1680	2×DN50	2×DN65
NEFX 8006 934 10D	173.09	139.14	933.5	284.8	10	1872.6	2×DN65	2×DN80

Modelo / Model	Ventilador con Motor Axial / Axial Fans							Desescarche Eléctrico Electric Defrost			
	Diámetro / Diameter (ø mm)	Nº	Voltaje / Voltage (V, 50Hz)	Potencia / Power (W)	Intensidad / Current (A)	Flujo de aire / Air Flow (m3/h)	Tiro / Air Throw (m)	Aletas / Coil (W)	Desagüe / Drain Pan (W)	Círculo del ventilador / Fan circle (W)	Total / Total (W)
NEFX 6302 119 10D	630	2	3 ~ 400	5400	10	34173	40	16 × 1510	2 × 1510	2 × 280	27740
NEFX 6302 148 10D	630	2	3 ~ 400	5400	10	32317	39	20 × 1510	2 × 1510	2 × 280	33780
NEFX 6302 187 10D	630	2	3 ~ 400	5400	10	30793	38	24 × 1510	2 × 1510	2 × 280	39820
NEFX 6304 238 10D	630	4	3 ~ 400	10800	20	68821	48	16 × 2740	2 × 2740	4 × 280	50440
NEFX 6304 297 10D	630	4	3 ~ 400	10800	20	65205	47	20 × 2740	2 × 2740	4 × 280	61400
NEFX 6304 383 10D	630	4	3 ~ 400	10800	20	62154	46	24 × 2740	2 × 2740	4 × 280	71800
NEFX 6306 358 10D	630	6	3 ~ 400	16200	30	103463	57	16 × 3800	2 × 3800	6 × 280	70080
NEFX 6306 446 10D	630	6	3 ~ 400	16200	30	98210	56	20 × 3800	2 × 3800	6 × 280	85280
NEFX 6306 580 10D	630	6	3 ~ 400	16200	30	93295	55	24 × 3800	2 × 3800	6 × 280	99360
NEFX 8002 187 10D	800	2	3 ~ 400	3200	7	37077	36	20 × 1800	2 × 1800	2 × 470	40540
NEFX 8002 249 10D	800	2	3 ~ 400	3200	7	35318	35	26 × 1800	2 × 1800	2 × 470	51340
NEFX 8002 303 10D	800	2	3 ~ 400	3200	7	33419	34	26 × 1800	2 × 1800	2 × 470	51340
NEFX 8004 381 10D	800	4	3 ~ 400	6400	14	74543	43	20 × 3200	2 × 3200	4 × 470	72280
NEFX 8004 509 10D	800	4	3 ~ 400	6400	14	71062	42	26 × 3200	2 × 3200	4 × 470	91480
NEFX 8004 618 10D	800	4	3 ~ 400	6400	14	67436	41	26 × 3200	2 × 3200	4 × 470	91480
NEFX 8006 576 10D	800	6	3 ~ 400	9600	21	111927	52	20 × 4800	2 × 4800	6 × 470	108420
NEFX 8006 767 10D	800	6	3 ~ 400	9600	21	106725	51	26 × 4800	2 × 4800	6 × 470	137220
NEFX 8006 934 10D	800	6	3 ~ 400	9600	21	101629	50	26 × 4800	2 × 4800	6 × 470	137220

FIN SPACING 12 mm, with electrical defrost. Rt>=-40°C

SEPARACIÓN ALETAS 12 mm, con desescarche eléctrico. Rt>=-40°C

Modelo / Model	Capacidad / Capacity R717 (kw)		Superficie / Surface (m ²)	Volumen interno / Tube Volume (dm ³)	Filas de serpentin / Coil Rows	Peso Neto / N.W. (kg)	Conexión / Connection (ømm)	
	te= -25°C	te= -31°C					Entrada / Inlet	Salida / Outlet
	DTI=7K	DTI=6K						
NEFX 6302 95 12D	22.45	18.62	112	34.2	6	430.9	DN40	DN50
NEFX 6302 127 12D	27.98	22.85	149.4	45.6	8	466.7	DN40	DN50
NEFX 6302 158 12D	32.24	27.04	158.4	57	10	516.4	DN40	DN50
NEFX 6304 195 12D	46.03	38.22	229.9	70.2	6	761.1	DN50	DN65
NEFX 6304 260 12D	57.4	46.97	306.6	93.5	8	831.8	DN50	DN65
NEFX 6304 325 12D	66.11	55.51	325.2	116.9	10	921.8	DN65	DN80
NEFX 6306 295 12D	69.6	57.83	347.8	106.1	6	1085.2	DN65	DN80
NEFX 6306 394 12D	87.38	72.88	463.8	141.5	8	1186	DN65	DN80
NEFX 6306 492 12D	102.85	85.11	492	176.9	10	1313.3	2×DN50	2×DN65
NEFX 8002 154 12D	30.11	25.15	190.9	58.2	6	587.2	DN40	DN50
NEFX 8002 206 12D	37.33	31.3	254.5	77.6	8	649.2	DN50	DN65
NEFX 8002 257 12D	43.33	36.48	257.1	92.4	10	719.9	DN50	DN65
NEFX 8004 315 12D	61.29	51.26	389.5	118.8	6	1040.3	DN65	DN80
NEFX 8004 420 12D	75.94	63.77	519.3	158.4	8	1157.3	DN65	DN80
NEFX 8004 525 12D	88.14	74.28	524.7	188.6	10	1287.4	2×DN50	2×DN65
NEFX 8006 475 12D	92.65	76.78	588.1	179.4	6	1489.7	2×DN50	2×DN65
NEFX 8006 634 12D	115.03	95.81	784.1	239.2	8	1659.7	2×DN50	2×DN65
NEFX 8006 792 12D	127.4	107.72	792.2	284.8	10	1847.2	2×DN65	2×DN80

Modelo / Model	Ventilador con Motor Axial / Axial Fans							Desescarche Eléctrico Electric Defrost			
	Diámetro / Diameter (ø mm)	Nº	Voltaje / Voltage (V, 50Hz)	Potencia / Power (W)	Intensidad / Current (A)	Flujo de aire / Air Flow (m3/h)	Tiro / Air Throw (m)	Aletas / Coil (W)	Desagüe / Drain Pan (W)	Círculo del ventilador / Fan circle (W)	Total / Total (W)
NEFX 6302 95 12D	630	2	3 ~ 400	5400	10	34755	40	16 × 1510	2 × 1510	2 × 280	27740
NEFX 6302 127 12D	630	2	3 ~ 400	5400	10	32982	39	20 × 1510	2 × 1510	2 × 280	33780
NEFX 6302 158 12D	630	2	3 ~ 400	5400	10	31514	38	24 × 1510	2 × 1510	2 × 280	39820
NEFX 6304 195 12D	630	4	3 ~ 400	10800	20	69962	48	16 × 2740	2 × 2740	4 × 280	50440
NEFX 6304 260 12D	630	4	3 ~ 400	10800	20	66488	47	20 × 2740	2 × 2740	4 × 280	61400
NEFX 6304 325 12D	630	4	3 ~ 400	10800	20	63621	46	24 × 2740	2 × 2740	4 × 280	71800
NEFX 6306 295 12D	630	6	3 ~ 400	16200	30	105163	57	16 × 3800	2 × 3800	6 × 280	70080
NEFX 6306 394 12D	630	6	3 ~ 400	16200	30	100130	56	20 × 3800	2 × 3800	6 × 280	85280
NEFX 6306 492 12D	630	6	3 ~ 400	16200	30	95474	55	24 × 3800	2 × 3800	6 × 280	99360
NEFX 8002 154 12D	800	2	3 ~ 400	3200	7	37687	36	20 × 1800	2 × 1800	2 × 470	40540
NEFX 8002 206 12D	800	2	3 ~ 400	3200	7	35942	35	26 × 1800	2 × 1800	2 × 470	51340
NEFX 8002 257 12D	800	2	3 ~ 400	3200	7	34331	34	26 × 1800	2 × 1800	2 × 470	51340
NEFX 8004 315 12D	800	4	3 ~ 400	6400	14	75754	43	20 × 3200	2 × 3200	4 × 470	72280
NEFX 8004 420 12D	800	4	3 ~ 400	6400	14	72265	42	26 × 3200	2 × 3200	4 × 470	91480
NEFX 8004 525 12D	800	4	3 ~ 400	6400	14	69247	41	26 × 3200	2 × 3200	4 × 470	91480
NEFX 8006 475 12D	800	6	3 ~ 400	9600	21	113736	52	20 × 4800	2 × 4800	6 × 470	108420
NEFX 8006 634 12D	800	6	3 ~ 400	9600	21	108517	51	26 × 4800	2 × 4800	6 × 470	137220
NEFX 8006 792 12D	800	6	3 ~ 400	9600	21	104361	50	26 × 4800	2 × 4800	6 × 470	137220

FIN SPACING 7 mm, with electrical defrost. Rt>=-20°C

SEPARACIÓN ALETAS 7 mm, con desescarche eléctrico. Rt>=-20°C

Modelo / Model	Capacidad / Capacity R717 (kw)		Superficie / Surface (m ²)	Volumen interno / Tube Volume (dm ³)	Filas de serpentin / Coil Rows	Peso Neto / N.W. (kg)	Conexión / Connection (ømm)	
	te= -8°C	te= -25°C					Entrada / Inlet	Salida / Outlet
	DTI=8K	DTI=7K						
NEFX Plus 6301 65 7D	13.34	11.54	64.8	14.2	4	289.4	DN25	DN32
NEFX Plus 6301 97 7D	18.87	16.13	97.3	21.4	6	319.7	DN25	DN32
NEFX Plus 6301 130 7D	23.53	19.81	129.7	28.5	8	360.5	DN32	DN40
NEFX Plus 6302 133 7D	28.54	22.05	133.1	29.2	4	499.6	DN32	DN40
NEFX Plus 6302 200 7D	40.35	31.07	199.6	43.8	6	555.4	DN40	DN50
NEFX Plus 6302 266 7D	50.22	38.53	266.2	58.5	8	628.5	DN40	DN50
NEFX Plus 6303 201 7D	42.58	35.43	201.3	44.2	4	713.4	DN40	DN50
NEFX Plus 6303 302 7D	60.13	49.56	302	66.3	6	799.9	DN50	DN65
NEFX Plus 6303 403 7D	74.74	61.01	402.7	88.4	8	905.5	DN50	DN65
NEFX Plus 6304 270 7D	57.86	44.73	269.6	59.2	4	920.9	DN50	DN65
NEFX Plus 6304 404 7D	81.8	62.98	404.4	88.8	6	1033.3	DN50	DN65
NEFX Plus 6304 539 7D	101.73	78.05	539.2	118.4	8	1169.1	2×DN40	2×DN50

Modelo / Model	Ventilador con Motor Axial / Axial Fans							Desescarche Eléctrico Electric Defrost			
	Diámetro / Diameter (ø mm)	Nº	Voltaje / Voltage (V, 50Hz)	Potencia / Power (W)	Intensidad / Current (A)	Flujo de aire / Air Flow (m3/h)	Tiro / Air Throw (m)	Aletas / Coil (W)	Desagüe / Drain Pan (W)	Círculo del ventilador / Fan circle (W)	Total / Total (W)
NEFX Plus 6301 65 7D	630	1	3 ~ 400	2700	5	18541	35	4 x 1510	2 x 1510	1 x 280	9340
NEFX Plus 6301 97 7D	630	1	3 ~ 400	2700	5	17727	34	7 x 1510	2 x 1510	1 x 280	13870
NEFX Plus 6301 130 7D	630	1	3 ~ 400	2700	5	16875	33	9 x 1510	2 x 1510	1 x 280	16890
NEFX Plus 6302 133 7D	630	2	3 ~ 400	5400	10	37056	39	4 x 2740	2 x 2740	2 x 280	17000
NEFX Plus 6302 200 7D	630	2	3 ~ 400	5400	10	35458	38	7 x 2740	2 x 2740	2 x 280	25220
NEFX Plus 6302 266 7D	630	2	3 ~ 400	5400	10	33797	37	9 x 2740	2 x 2740	2 x 280	30700
NEFX Plus 6303 201 7D	630	3	3 ~ 400	8100	15	55763	43	4 x 3800	2 x 3800	3 x 280	23640
NEFX Plus 6303 302 7D	630	3	3 ~ 400	8100	15	53448	42	7 x 3800	2 x 3800	3 x 280	35040
NEFX Plus 6303 403 7D	630	3	3 ~ 400	8100	15	50959	41	9 x 3800	2 x 3800	3 x 280	42640
NEFX Plus 6304 270 7D	630	4	3 ~ 400	10800	20	74232	47	4 x 5060	2 x 5060	4 x 280	31480
NEFX Plus 6304 404 7D	630	4	3 ~ 400	10800	20	71118	45	7 x 5060	2 x 5060	4 x 280	46660
NEFX Plus 6304 539 7D	630	4	3 ~ 400	10800	20	67825	43	9 x 5060	2 x 5060	4 x 280	56780

FIN SPACING 12 mm, with electrical defrost. Rt>=-40°C

SEPARACIÓN ALETAS 12 mm, con desescarche eléctrico. Rt>=-40°C

Modelo / Model	Capacidad / Capacity R717 (kw)		Superficie / Surface (m ²)	Volumen interno / Tube Volume (dm ³)	Filas de serpentin / Coil Rows	Peso Neto / N.W. (kg)	Conexión / Connection (ømm)	
	te= -25°C	te= -31°C					Entrada / Inlet	Salida / Outlet
	DTI=7K	DTI=6K						
NEFX Plus 6301 40 12D	8.14	6.71	39.6	14.2	4	282.7	DN25	DN32
NEFX Plus 6301 59 12D	11.6	9.59	59.4	21.4	6	321.3	DN25	DN32
NEFX Plus 6301 79 12D	14.59	12.12	79.2	28.5	8	346.9	DN32	DN40
NEFX Plus 6302 81 12D	17.1	14.15	81.3	29.2	4	484.2	DN32	DN40
NEFX Plus 6302 122 12D	24.6	20.43	122	43.8	6	535.1	DN40	DN50
NEFX Plus 6302 163 12D	31.24	26.05	162.6	58.5	8	600	DN40	DN50
NEFX Plus 6303 123 12D	26.34	22	123	44.2	4	693	DN40	DN50
NEFX Plus 6303 185 12D	37.81	31.43	184.5	66.3	6	767.8	DN50	DN65
NEFX Plus 6303 246 12D	47.68	39.62	246	88.4	8	864.5	DN50	DN65
NEFX Plus 6304 165 12D	34.61	28.67	164.7	59.2	4	892.3	DN50	DN65
NEFX Plus 6304 247 12D	49.79	41.38	247.1	88.8	6	990.5	DN50	DN65
NEFX Plus 6304 329 12D	63.21	52.75	329.4	118.4	8	1114.6	2×DN40	2×DN50

Modelo / Model	Ventilador con Motor Axial / Axial Fans							Desescarche Eléctrico Electric Defrost			
	Diámetro / Diameter (ø mm)	Nº	Voltaje / Voltage (V, 50Hz)	Potencia / Power (W)	Intensidad / Current (A)	Flujo de aire / Air Flow (m3/h)	Tiro / Air Throw (m)	Aletas / Coil (W)	Desagüe / Drain Pan (W)	Circulo del ventilador / Fan circle (W)	Total / Total (W)
NEFX Plus 6301 40 12D	630	1	3 ~ 400	2700	5	18955	36	4 x 1510	2 x 1510	1 x 280	9340
NEFX Plus 6301 59 12D	630	1	3 ~ 400	2700	5	18336	35	7 x 1510	2 x 1510	1 x 280	13870
NEFX Plus 6301 79 12D	630	1	3 ~ 400	2700	5	17728	34	9 x 1510	2 x 1510	1 x 280	16890
NEFX Plus 6302 81 12D	630	2	3 ~ 400	5400	10	37871	40	4 x 2740	2 x 2740	2 x 280	17000
NEFX Plus 6302 122 12D	630	2	3 ~ 400	5400	10	36644	39	7 x 2740	2 x 2740	2 x 280	25220
NEFX Plus 6302 163 12D	630	2	3 ~ 400	5400	10	35447	38	9 x 2740	2 x 2740	2 x 280	30700
NEFX Plus 6303 123 12D	630	3	3 ~ 400	8100	15	56961	44	4 x 3800	2 x 3800	3 x 280	23640
NEFX Plus 6303 185 12D	630	3	3 ~ 400	8100	15	55162	43	7 x 3800	2 x 3800	3 x 280	35040
NEFX Plus 6303 246 12D	630	3	3 ~ 400	8100	15	53439	42	9 x 3800	2 x 3800	3 x 280	42640
NEFX Plus 6304 165 12D	630	4	3 ~ 400	10800	20	75837	48	4 x 5060	2 x 5060	4 x 280	31480
NEFX Plus 6304 247 12D	630	4	3 ~ 400	10800	20	73420	47	7 x 5060	2 x 5060	4 x 280	46660
NEFX Plus 6304 329 12D	630	4	3 ~ 400	10800	20	71097	46	9 x 5060	2 x 5060	4 x 280	56780

AVAILABLE OPTIONS FOR NEFX SERIES

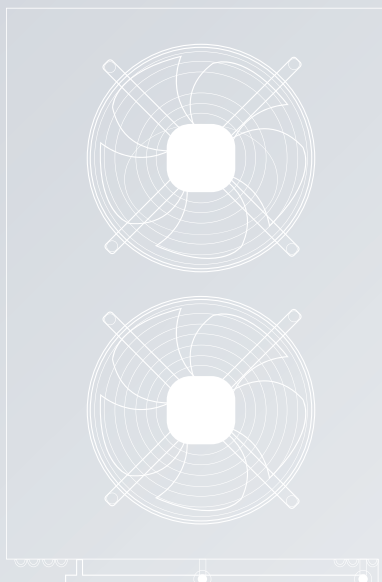
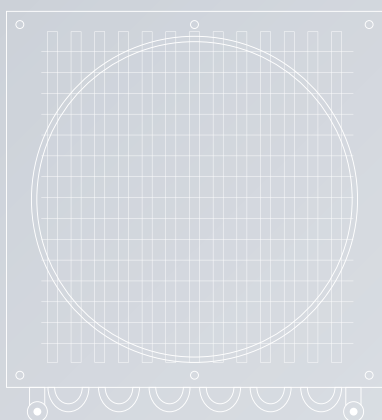
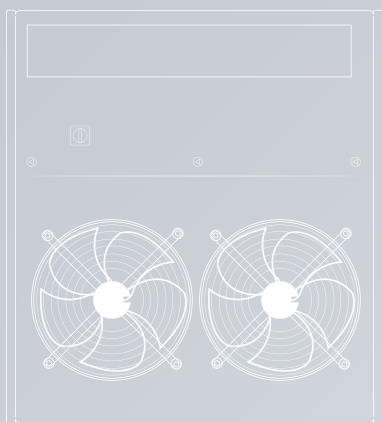
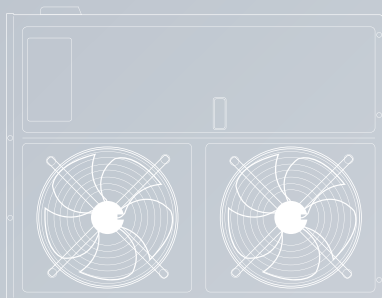

Defrost options:

- Air
- Electrical defrost
- Hot gas
- Water
- Hot gas for coil and electrical for tray
- Water and electrical



Tube material options:

- Stainless steel AISI SUS304



Coil protection options:

- Aluminium fins
- Fins with GOLDFIN anti-corrosion high resistance coating



Fan options:

- EC Fans
- Silica gel heaters for fan nozzles, only for $\varnothing 500$ mm or above
- Streamers: Airk-guiding device for increased airthrow



Casing options:

- White powder-coated painted aluminium
- Stainless steel AISI SUS304



Other options:

- Double insulated drip tray (recommended for low temperature applications)
- Thermal protector for defrosting electrical heaters

OPCIONES DISPONIBLES PARA LA SERIE NEFX



Opciones de desescarche:

- Aire
- Desescarche eléctrico
- Gas caliente
- Agua
- Aas caliente en serpentín y eléctrico en bandeja
- Agua y eléctrico



Tube material options:

- Acero inoxidable AISI SUS304



Coil protection options:

- Aleta de aluminio
- Aleta con tratamiento GOLDFIN con anticorrosión de alta resistencia



Fan options:

- Ventiladores EC
- Resistencias calefactoras para aro de ventiladores, sólo para modelos $\varnothing 500$ mm o más grandes
- Streamers: Dispositivo de aire guiado para incrementar el tiro de aire



Casing options:

- Aluminio pintado al polvo blanco
- acero inoxidable AISI SUS304



Other options:

- Bandeja de goteo con doble aislamiento (recomendada en aplicaciones con cámaras de baja temperatura)
- Protector térmico para resistencias de desescarche

Business Scope

Ámbito de Negocio



China | Chile | Israel | Spain | Colombia | Australia | Mexico | Thailand | United Kingdom | North Macedonia | New Zealand | Algeria | Ukraine | Malaysia | Poland | Peru | Uruguay | Russia | Hungary | Panama | Bulgaria | India | Ecuador | USA | Yemen | France | Malta | Saudi Arabia | Gabon | El Salvador | Lebanon | Turkey | Dominican Republic | Argentina | Syria | Italy | Venezuela | Singapore | Madagascar | Dubai | Uzbekistan | Costa Rica | Philippines | Honduras | Cyprus | Taiwan, China | Ghana | Jordan | Maldives | Qatar | Belgium | Albania

China | Chile | Israel | España | Colombia | Australia | México | Tailandia | Reino Unido | Macedonia del Norte | Nueva Zelanda | Argelia | Ucrania | Malasia | Polonia | Perú | Uruguay | Rusia | Hungría | Panamá | Bulgaria | India | Ecuador | EE.UU | Yemen | Francia | Malta | Arabia Saudita | Gabón | El Salvador | Líbano | Turquía | República Dominicana | Argentina | Siria | Italia | Venezuela | Singapur | Madagascar | Dubái | Uzbekistán | Costa Rica | Filipinas | Honduras | Chipre | Taiwán, China | Ghana | Jordania | Maldivas | Catar | Bélgica | Albania





TAIZHOU HISPANIA
REFRIGERATION EQUIPMENT CO., LTD.



ADDRESS

No. 10, Standard Factory Building B, High-Tech Park, Taizhou Economic Development Zone, Jiangsu Province, China

DIRECCIÓN

No. 10, Área B, Edificio de fábrica estándar, Parque de alta tecnología, Zona de desarrollo económico de Taizhou, Provincia de Jiangsu, China



PHONE/TELEFONO:

+86 523-80805008 +86 523-86848116 +86 523-80805001



EMAIL/CORREO ELECTRÓNICO:

ellen@hispaniacorp.com | annie@hispaniacorp.com | jackie@hispaniacorp.com
